

JLC

Beam Delivery System

3-7, July 2000

JLC-FFIR group, T.Tauchi

<http://acfahep.kek.jp/member/subg/ir.html> for the members

1. Collimation System

2. Final Focus System

3. Interaction Region

QC1, Background, Instruments etc.

4. Dump Line

5. Future Plan

500GeV (CM) Hi-Lum Parameters of JLC

		A	X	Y
Luminosity	$10^{34}/\text{cm}^2\text{s}$	0.88	1.57	2.61
Nominal Lum. ³⁾	$10^{34}/\text{cm}^2\text{s}$	0.63	1.08	1.75
Bunch Population	10^{10}	0.75	0.55	0.70
No. of bunches/pulse		95	190	190
Bunch separation	ns	2.8	1.4	1.4
Linac length/beam ⁷⁾	km	5.21	5.54	5.97
AC power(2 linacs)	MW	117	126	136
Beam power/beam	MW	4.28	6.28	7.99
Loaded gradient ⁴⁾	MV/m	57.6	54.2	50.2
Bunch length σ_z	μm	90	80	80
$\gamma\mathcal{E}_x$ (DR exit)	10^{-6} m	3	3	3
$\gamma\mathcal{E}_y$ (DR exit)	10^{-6} m	0.03	0.02	0.02
$\gamma\mathcal{E}_x$ (IP)	10^{-6} m	4	4	4
$\gamma\mathcal{E}_y$ (IP)	10^{-6} m	0.06	0.04	0.04
Cavity align. tol. ⁶⁾	μm	15	18	14
β_x^*	mm	10	6	6
β_y^*	mm	0.1	0.1	0.1
IP beam size σ_x^*	nm	286	222	222
σ_y^*	nm	3.15	2.86	2.86
Diagonal angle σ_x^*/σ_z	mrad	3.18	2.77	2.77
Disruption param D_x		0.094	0.102	0.130
D_y		7.64	7.89	10.04
Pinch enh. H_D ⁵⁾		1.38	1.45	1.49
Υ_{ave}		0.136	0.146	0.188
δ_{BS}	%	4.42	4.39	6.67
n_γ		1.07	1.01	1.28

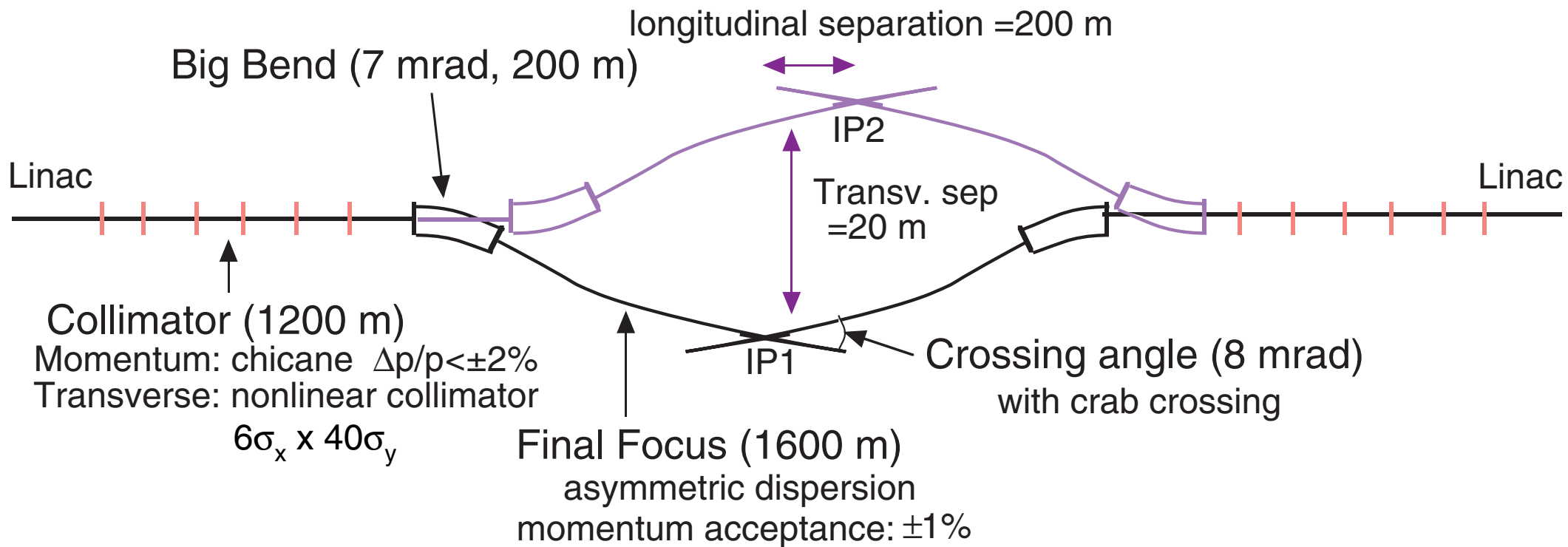

JLC: Beam Delivery System

Probability of tail; gas scattering

$$\sigma_{el}(\theta > \theta_o) = 4 \frac{\pi Z^2 r_e^2}{\gamma^2} \frac{1}{\theta_o^2}$$

$$\theta_o = n \sqrt{\frac{\epsilon}{\beta}}$$

$$P_{tail} = N_{gas} \frac{4\pi Z^2 r_e^2}{\gamma^2 n^2} \frac{1}{\epsilon} \int \beta ds$$

tail (= beam halo)
outside of
 $6\sigma_x \times 40\sigma_y$

$$N_{gas} = 3.6 \times 10^{22} P(\text{torr}), Z(\text{CO}) = 14, r_e = 2.8 \times 10^{-15} \text{ m}$$

$$\gamma \epsilon_y = 3 \times 10^{-8} \text{ mrad}, \gamma = 0.25 \times 10^6 (E_{beam} = 250 \text{ GeV})$$

$$P_{tail}^y = 0.01 \times P_{tail}^x = 0.08 P \frac{1}{n_{y(x)}^2} \int \beta_{y(x)} ds$$

Assuming $P = 10^{-8}$ torr and $n_x = 6, n_y = 40,$

(1) Pre-linac Collimation

$$s = 11500 \text{ m}, \beta_x = \beta_y = 100 \text{ m}$$

$$P_{tail}^y = 5 \times 10^{-7}, P_{tail}^x = 2 \times 10^{-7}$$

(2) Post-linac Collimation

$$\int \beta_{y(x)} ds = 2.6 \times 10^7 (1.6 \times 10^6) \text{ m}, s_{FF} = 588.4 \text{ m}$$

$$P_{tail}^y = 1.3 \times 10^{-5}, P_{tail}^x = 3.6 \times 10^{-7}$$

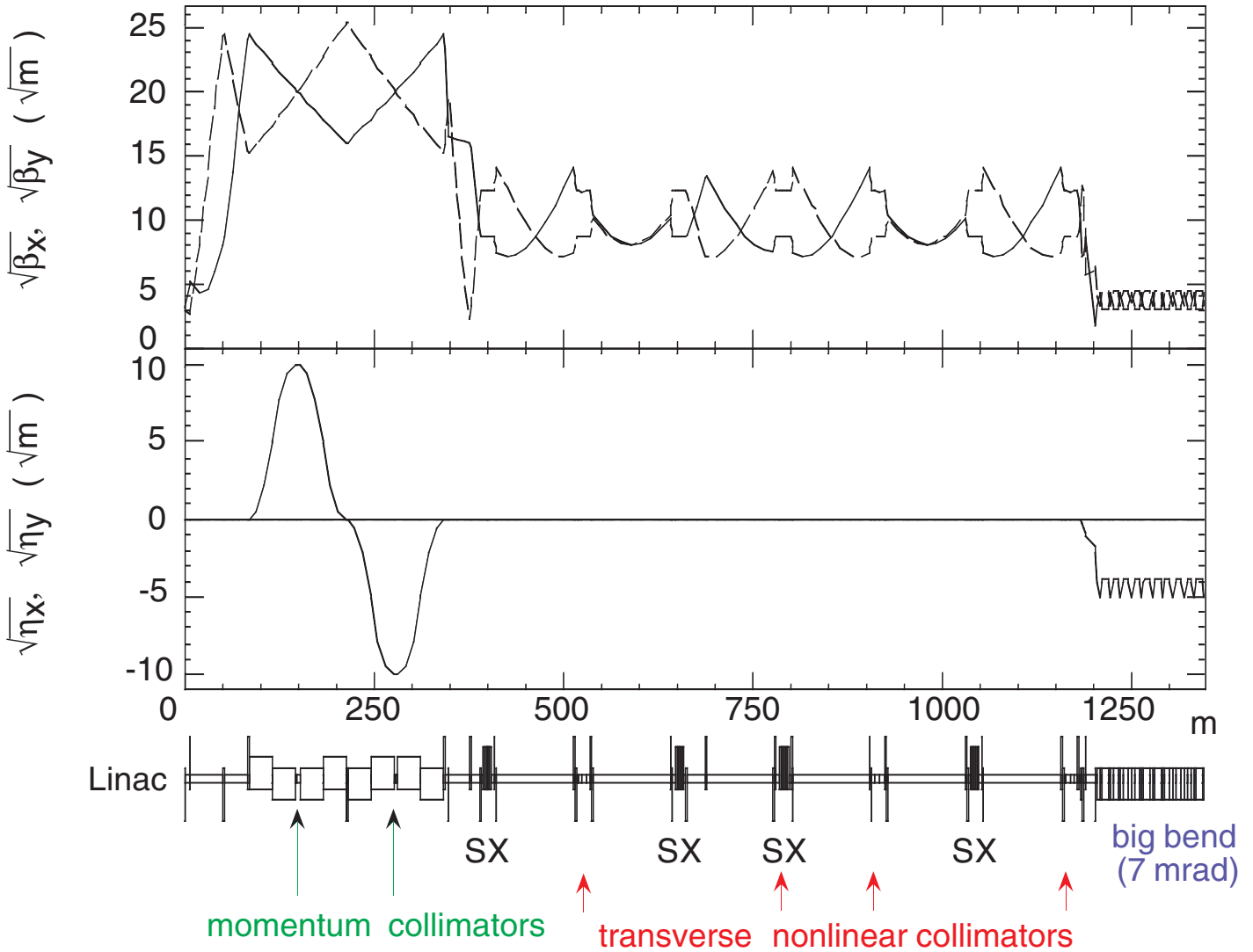

Location of bending magnets and collimators

element	s from IP (m)	function
bend1	90	-3.28 mrad
bend2	1600	7 mrad
COLLI1.8	1840.3	x', y' second colli.
COLLI1.7	1966.7	x', y' first colli.
COLLI1.6	2093.1	x, y second colli.
COLLI1.5	2219.5	x, y' first colli.
COLLI1.4	2357.4	momentum second colli.
COLLI1.3	2483.9	momentum first colli.
COLLI1.2	2725.4	(in the linac)
COLLI1	2855.6	(in the linac)



图 1: JP27 optics for T-JLC by K. Okle

k_2 2.58 SF
 -0.88 SD



图 2: 1.5 m optics by Pantaleo

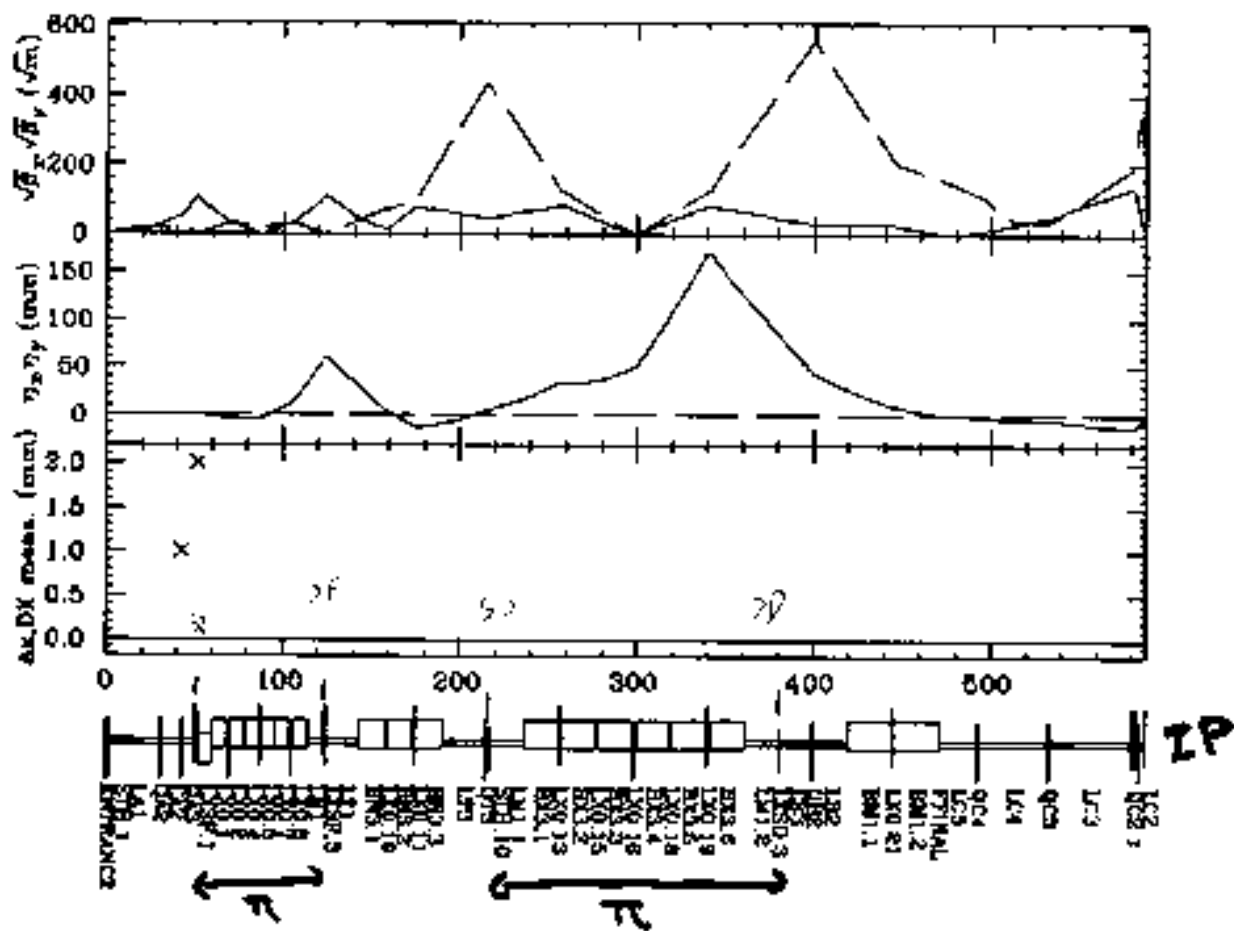

$K_2 @ SDO \sim 330$

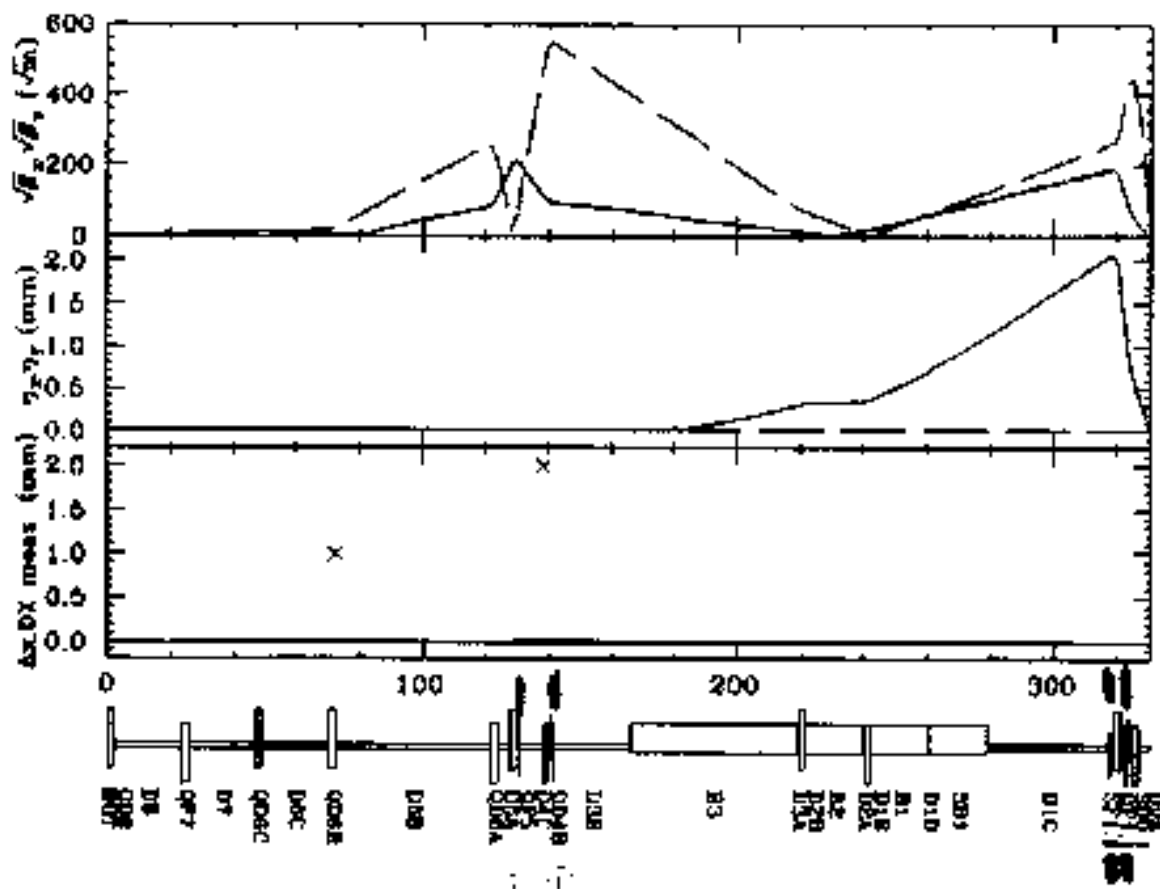
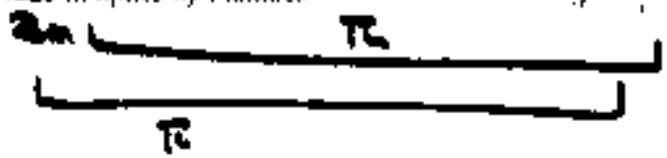
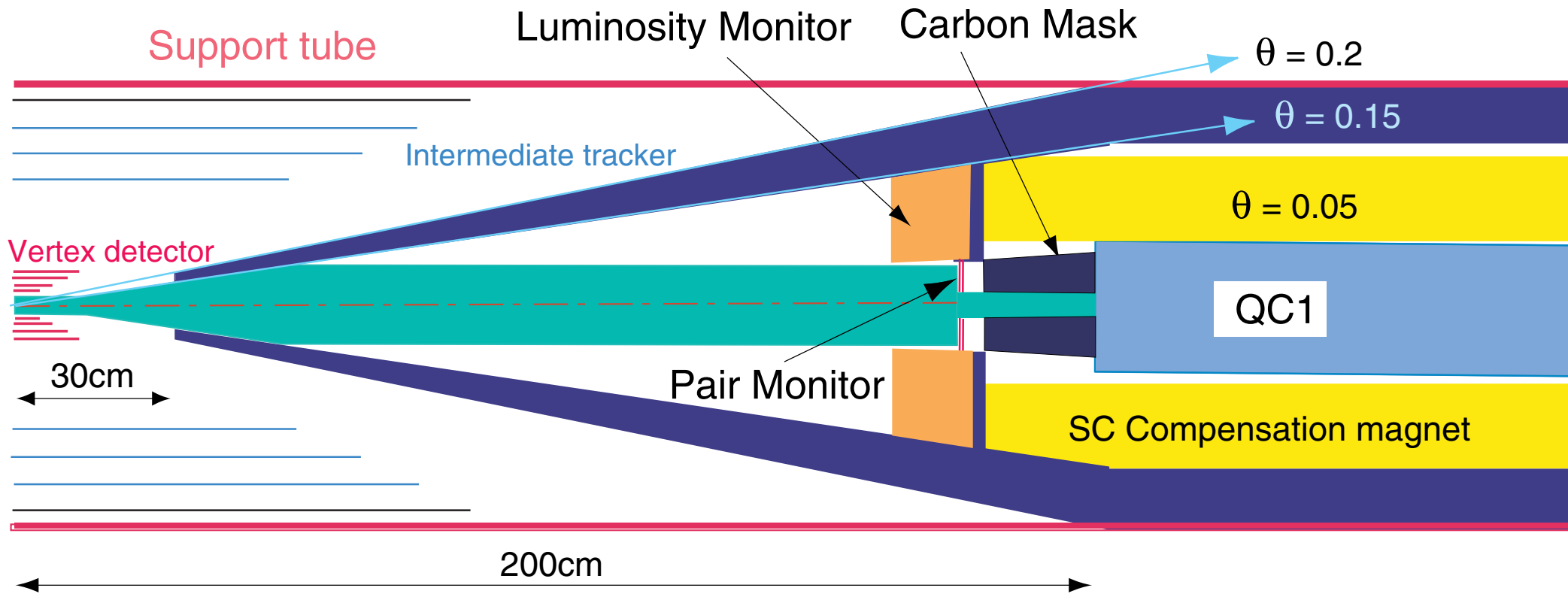

Support Tube (80cm ϕ x 12m) Analysis by ANSYS

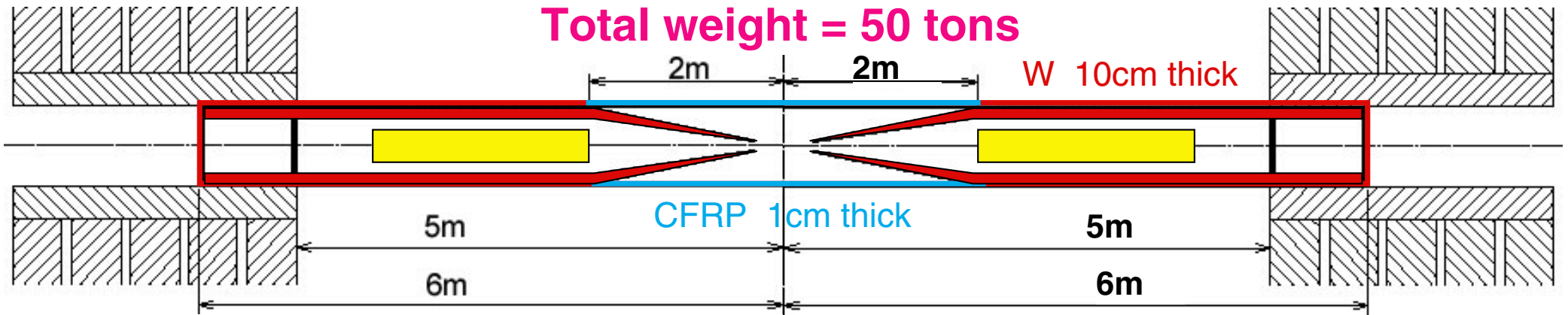

Result; Gravitational Sag

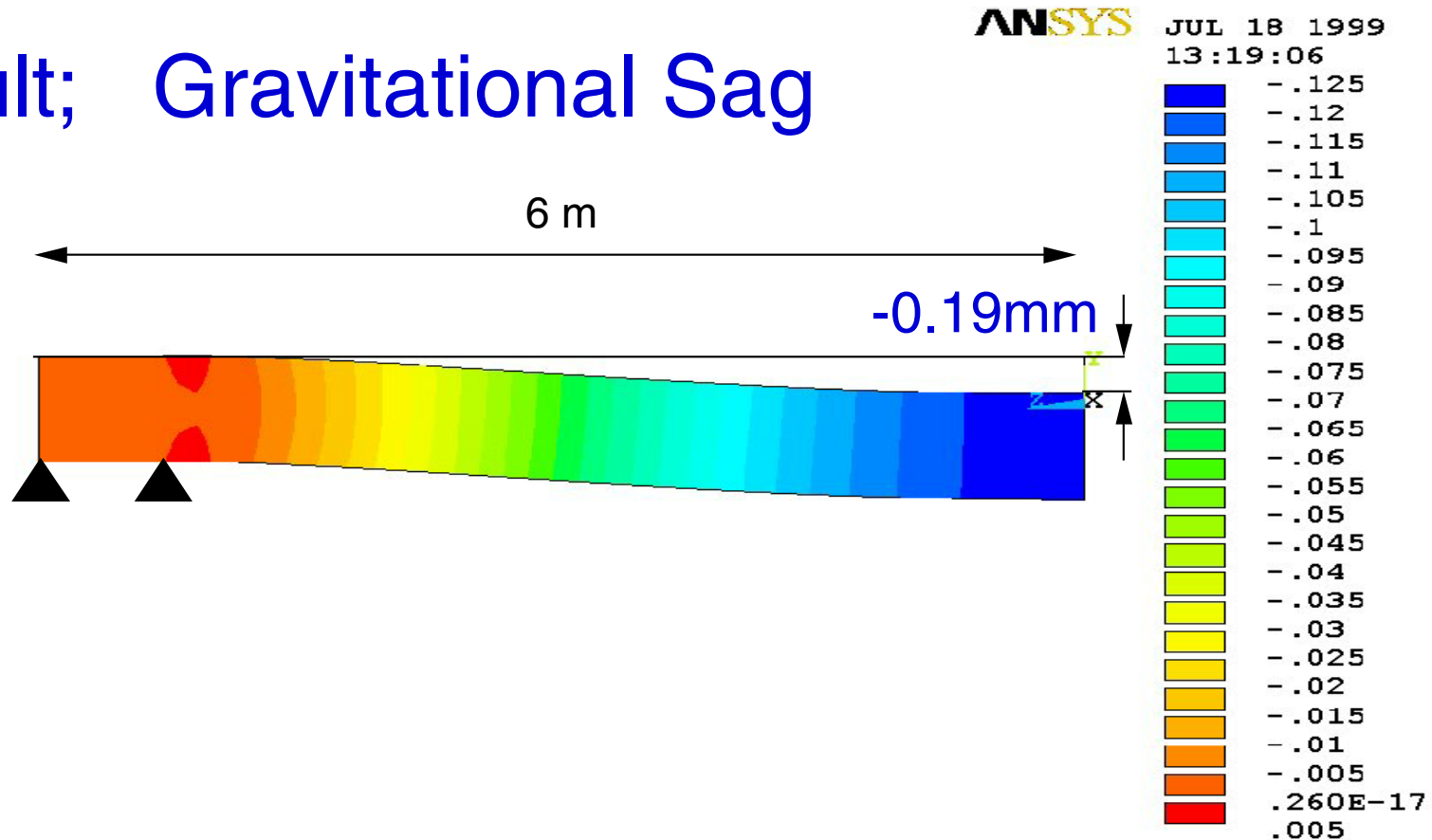

Backgrounds

(1) Muons

10^7 muons/trains at the collimators

Assuming 0.1% flat beam-tail, 10^{-3} (tail) x 10^{10} (beam)x 10^2 (bunch)= 10^9 electrons/train would hit the collimators.

Tolerance: One muon in $16 \times 16 \times 16 \text{m}^3$ at IP

(2) Synchrotron radiations in FF-system.

collimation is important: $6 \sigma_x \times 40 \sigma_y$

(3) e^+e^- pairs created in collisions

number of pairs 25,000 / bunch

average energy 4 GeV ($E_e > 3 \text{MeV}$)

total energy 100 TeV / bunch

signals for pair monitor for $E_e = 300 \sim 500 \text{MeV}$

(4) neutrons (1 neutron/100MeV)

pairs at QC1 and masks $\sim 30 \text{ TeV} / \text{ bunch}$

3×10^5 neutrons / bunch

beamstrahlung photons 340 kW (4% \times 2)

2×10^{16} neutrons / sec

disrupted beam in dump line

Muon Attenuator

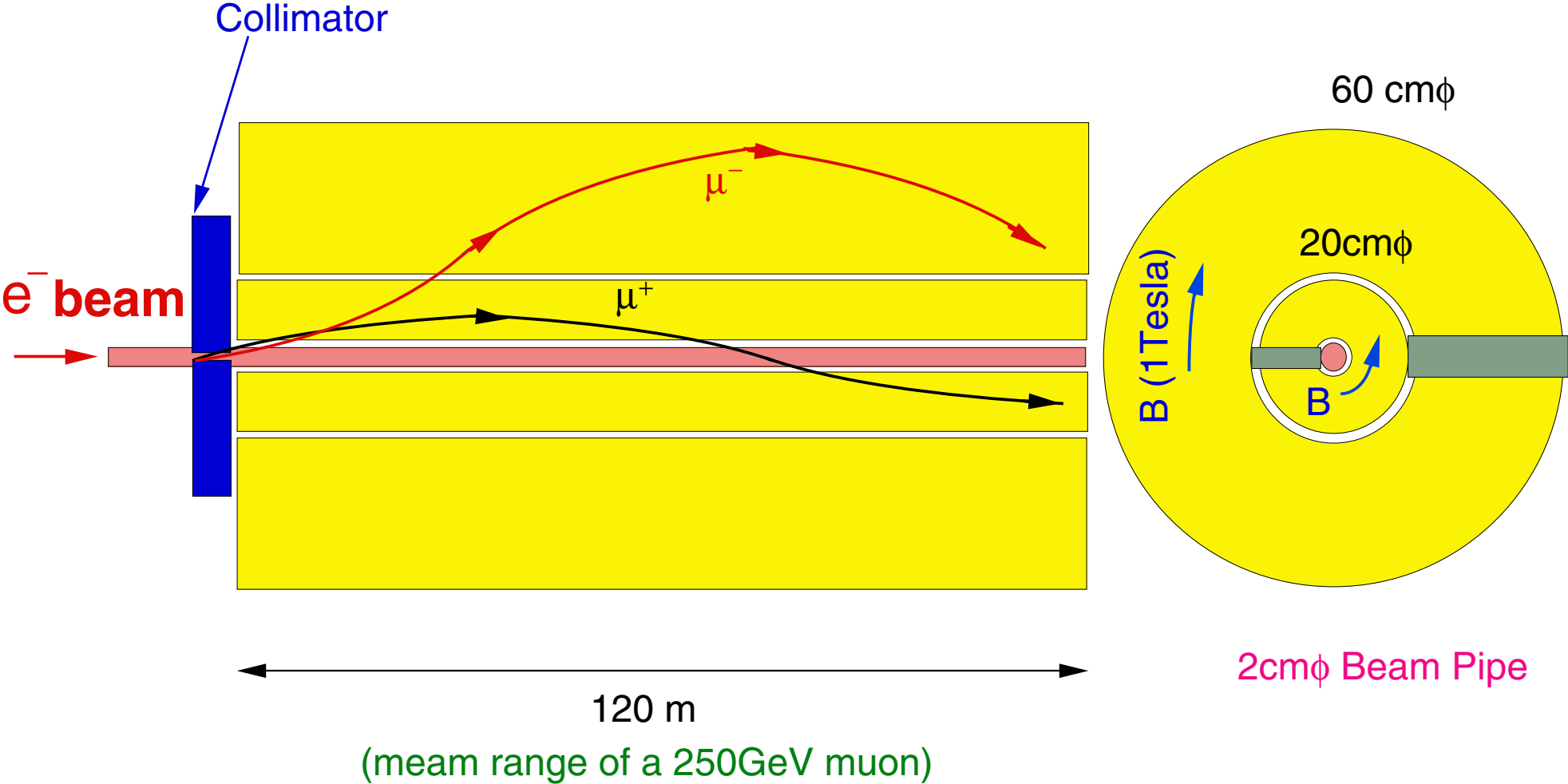

Y.Namito, ISG3, SLAC, Jan.1999

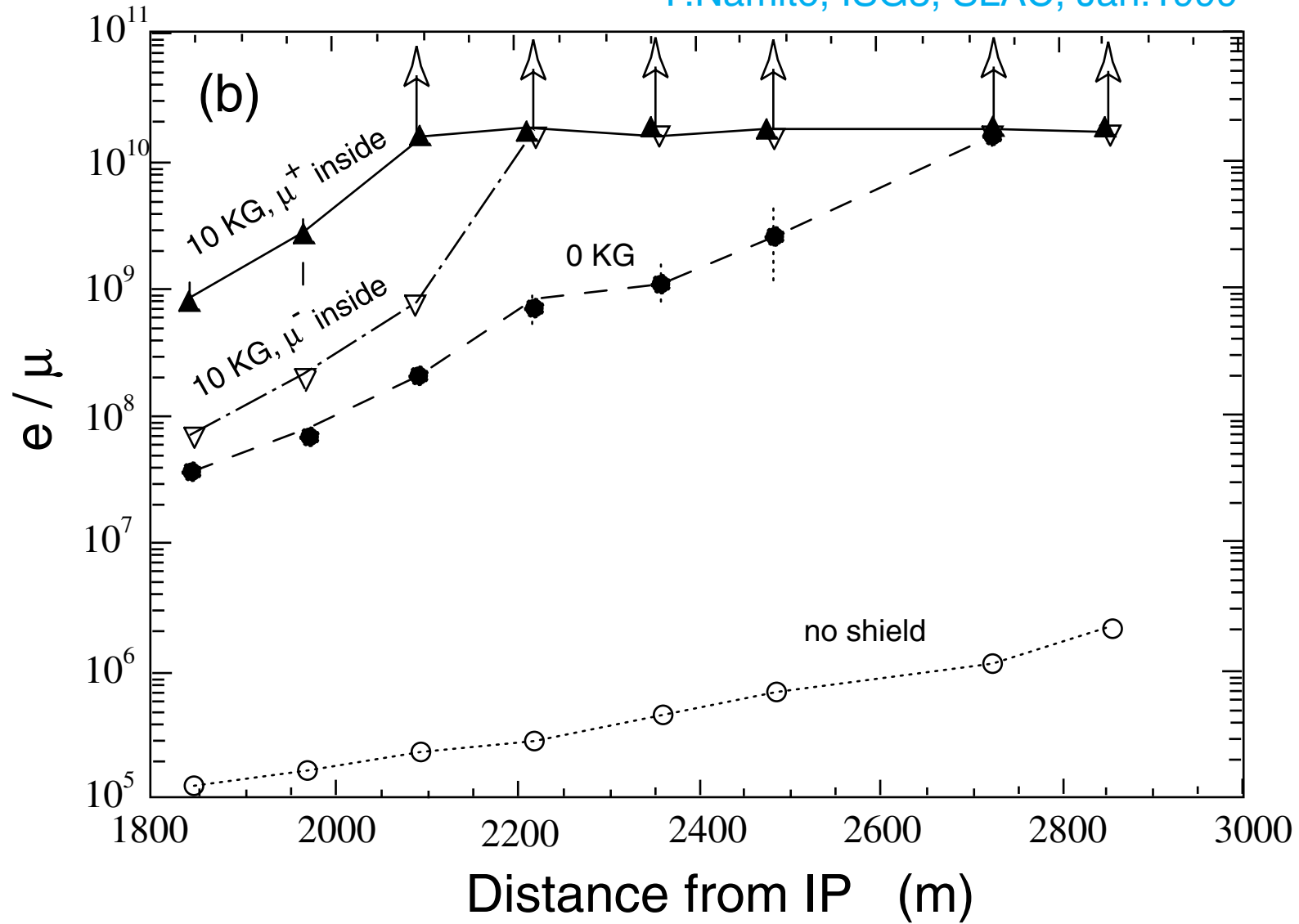

QC1 and Synchrotron Radiation

note: 9cm ϕ aperture for super conducting QC1, Jan.2000

note: 4cm ϕ beam pipe just in front of QC1

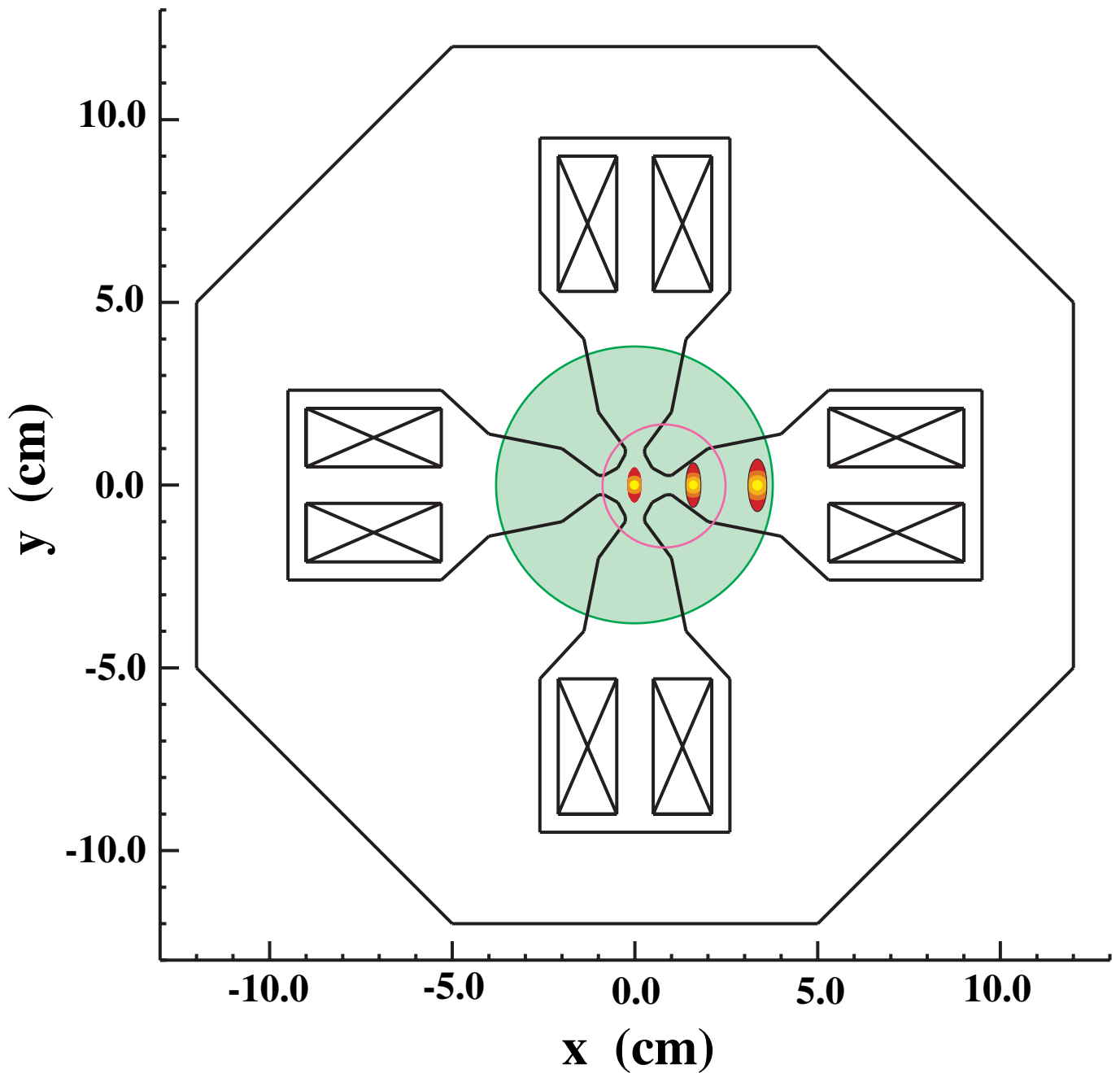

Envelop of Collimated Beam

JLC Design Study, April, 1997

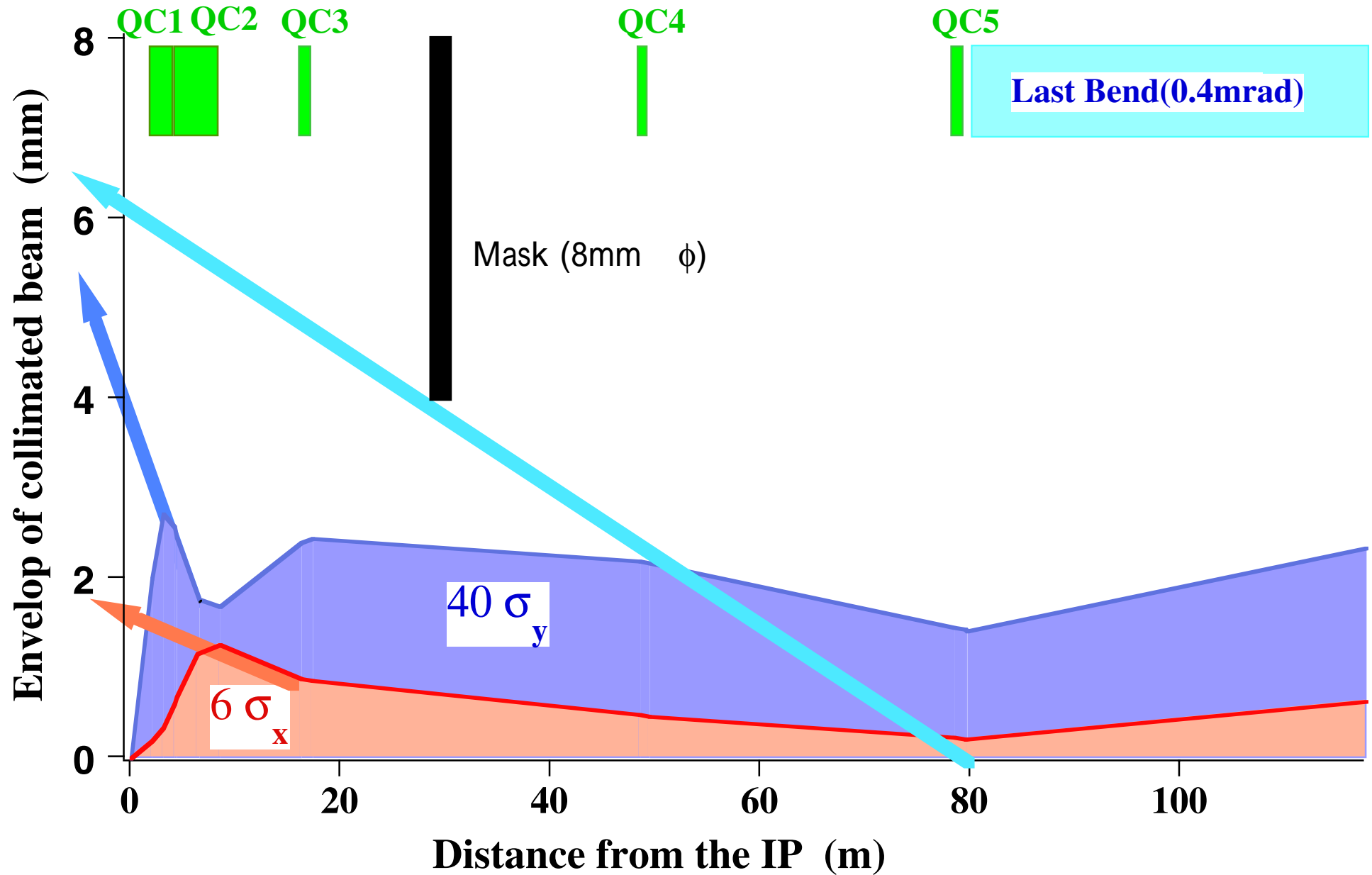

Miyamoto, June 2000

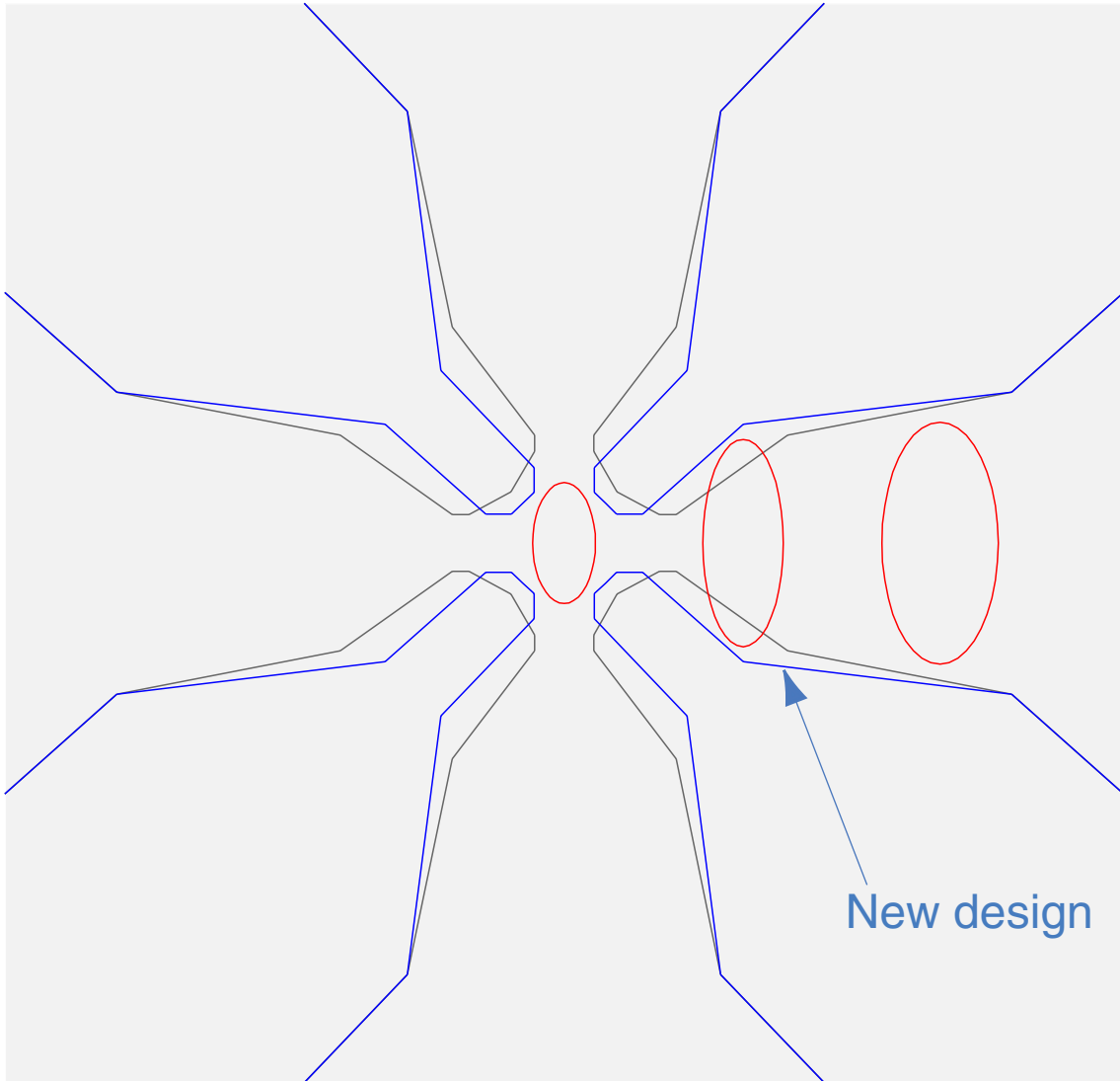

QC1: $z=200\text{cm}$
Crossing Angle: 8mrad

Miyamoto, June 2000

1

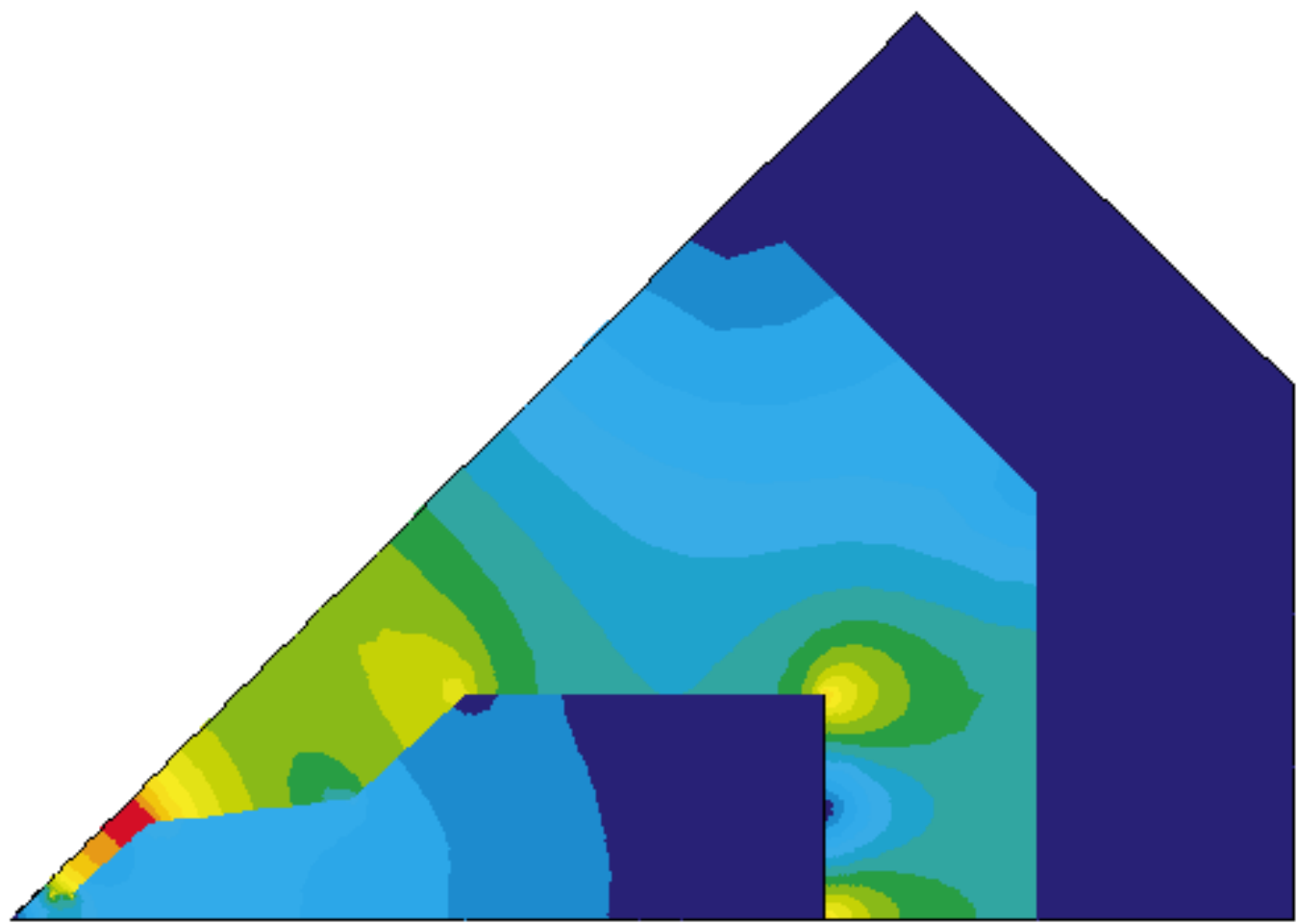

```
ANSYS 5.4  
MAY 31 2000  
13:36:09  
NODAL SOLUTION  
STEP=1  
SUB =6  
TIME=1  
BSUM      (AVG)  
RSYS=0  
PowerGraphics  
EFACET=1  
AVRES=Mat  
SMN  =.330E-08  
SMX  =2.925  
  
■ .330E-08  
■ .182799  
■ .365599  
■ .548398  
■ .731197  
■ .913997  
■ 1.097  
■ 1.28  
■ 1.462  
■ 1.645  
■ 1.828  
■ 2.011  
■ 2.194  
■ 2.376  
■ 2.559  
■ 2.742  
■ 2.925
```

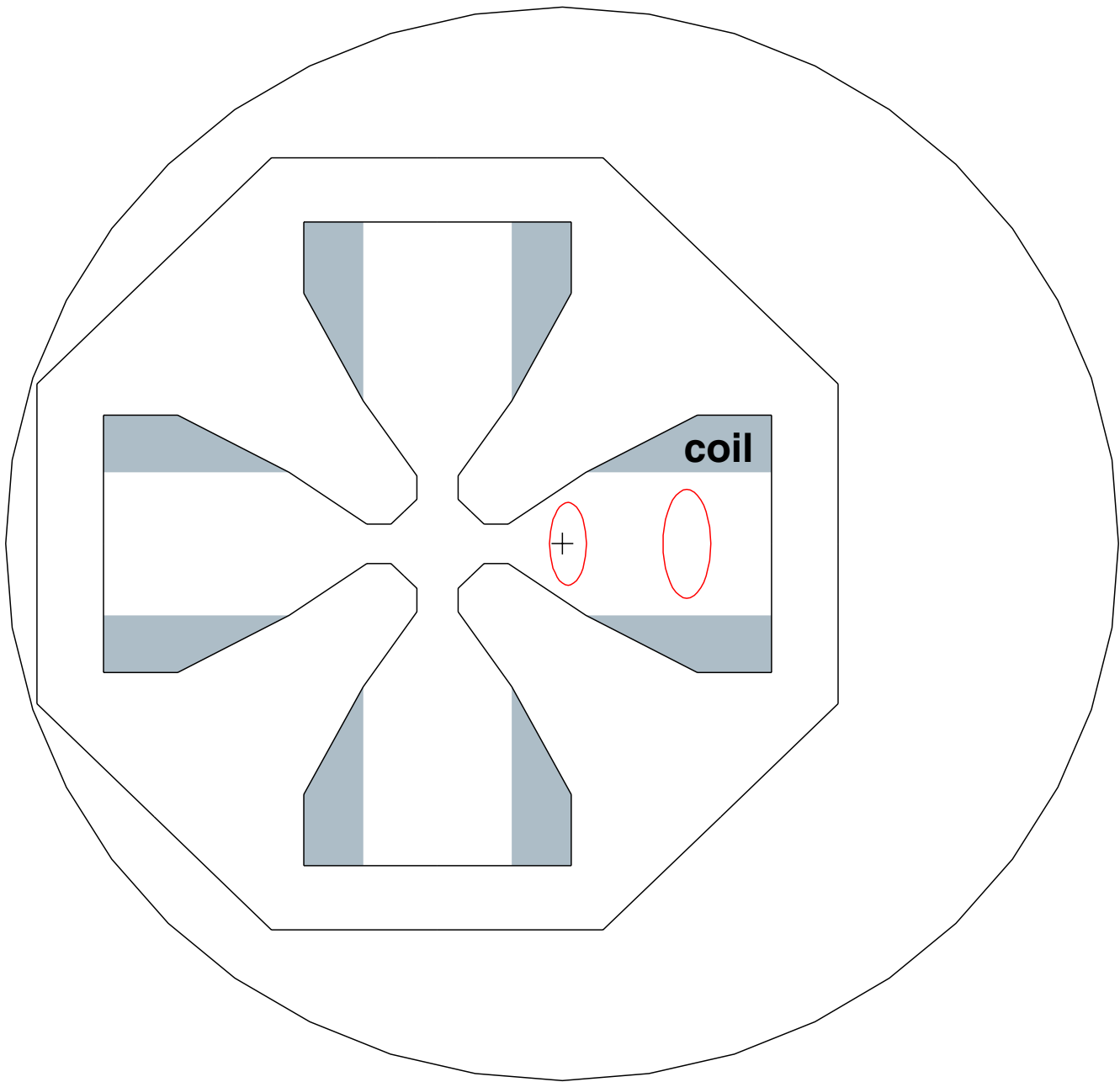
QC2 and Compensation coil at Z=840cm

Miyamoto, June 2000

ANSYS 5.4

JUN 2 2000

15:42:07

ELEMENT SOLUTION

STEP=1

SUB =6

TIME=1

BSUM (NOAVG)

RSYS=0

PowerGraphics

EFACET=1

SMN =.136E-08

SMX =2.615

.136E-08

.16343

.32686

.49029

.65372

.817149

.980579

1.144

1.307

1.471

1.634

1.798

1.961

2.125

2.288

2.451

2.615

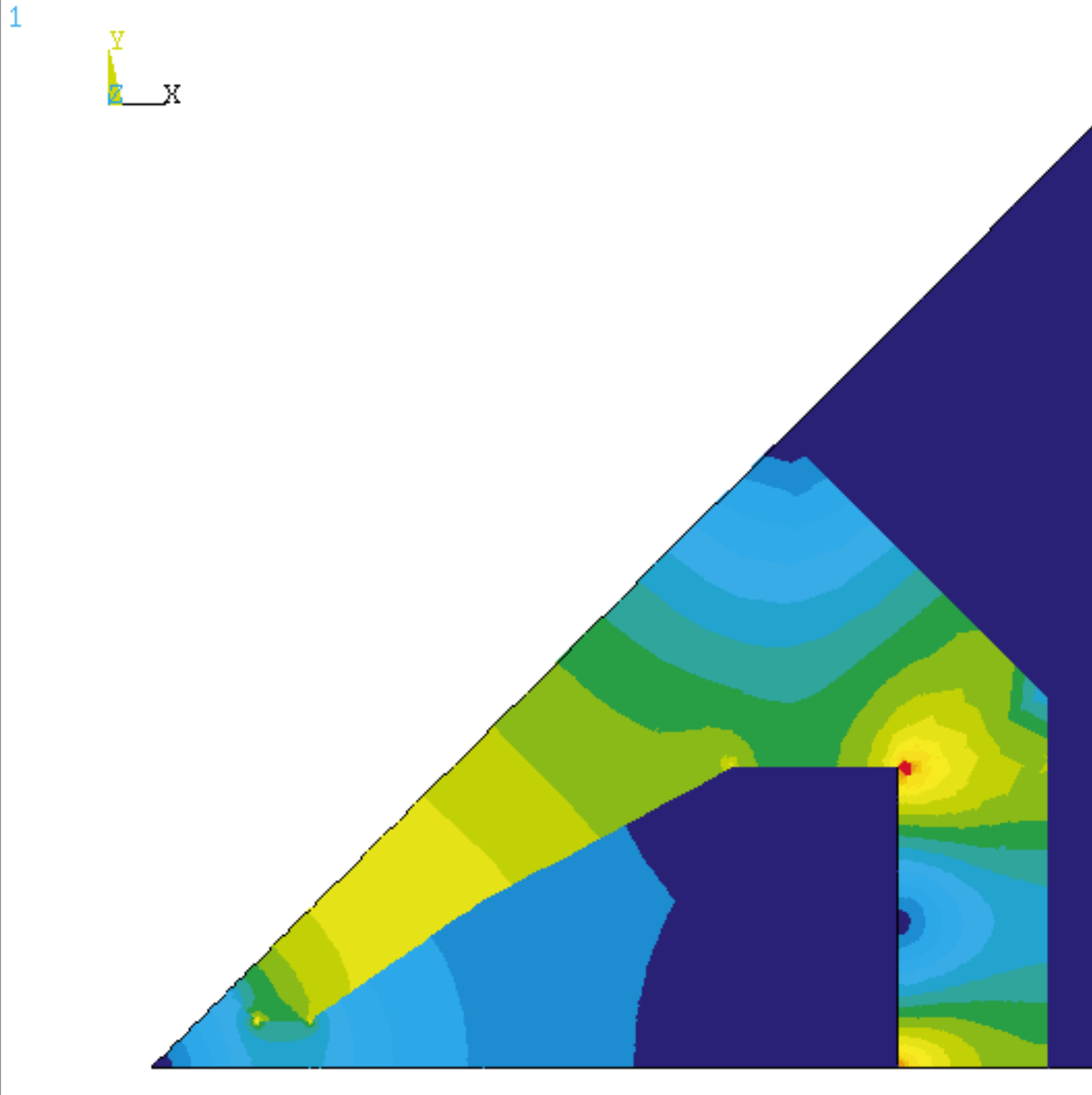

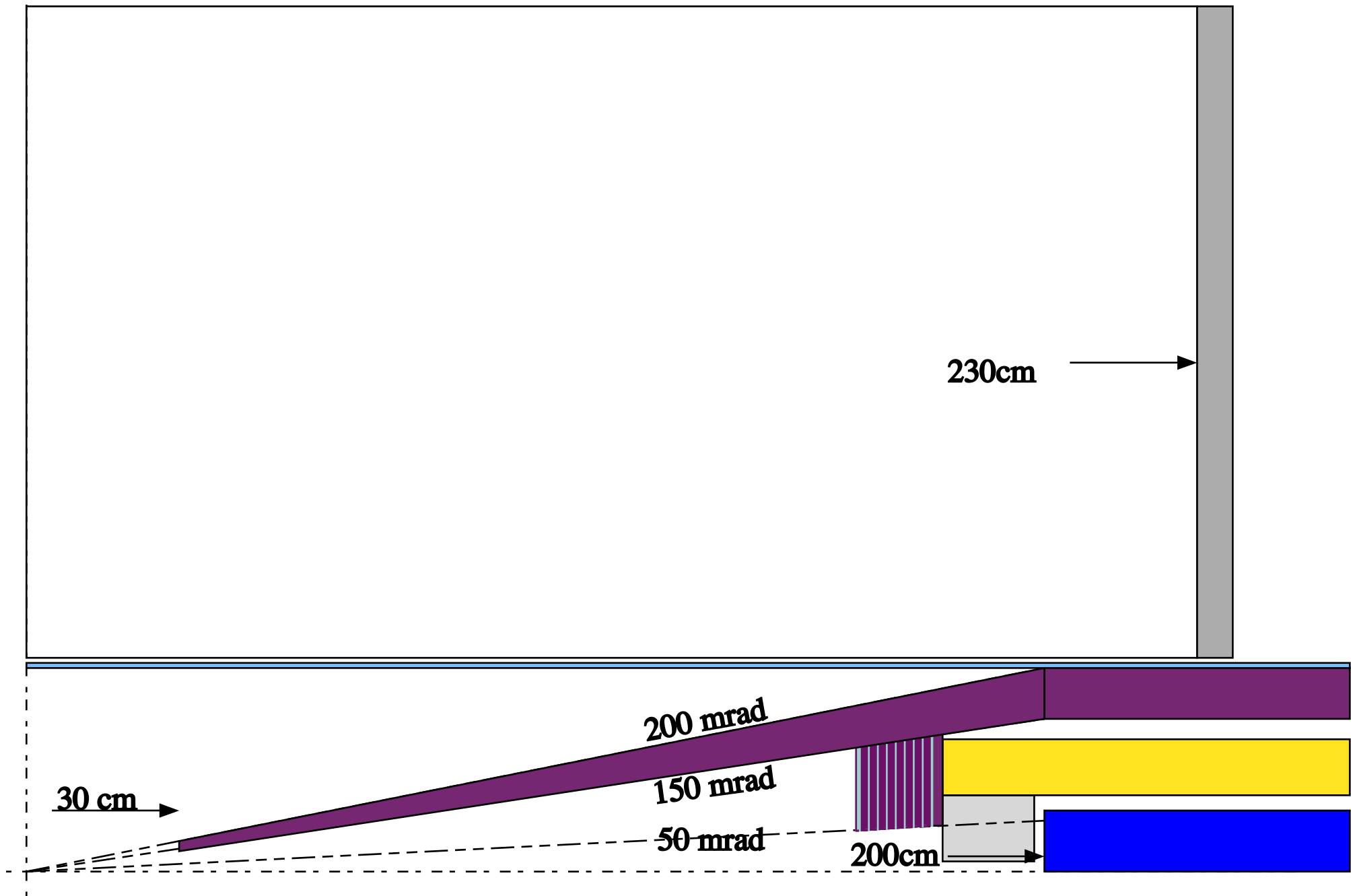

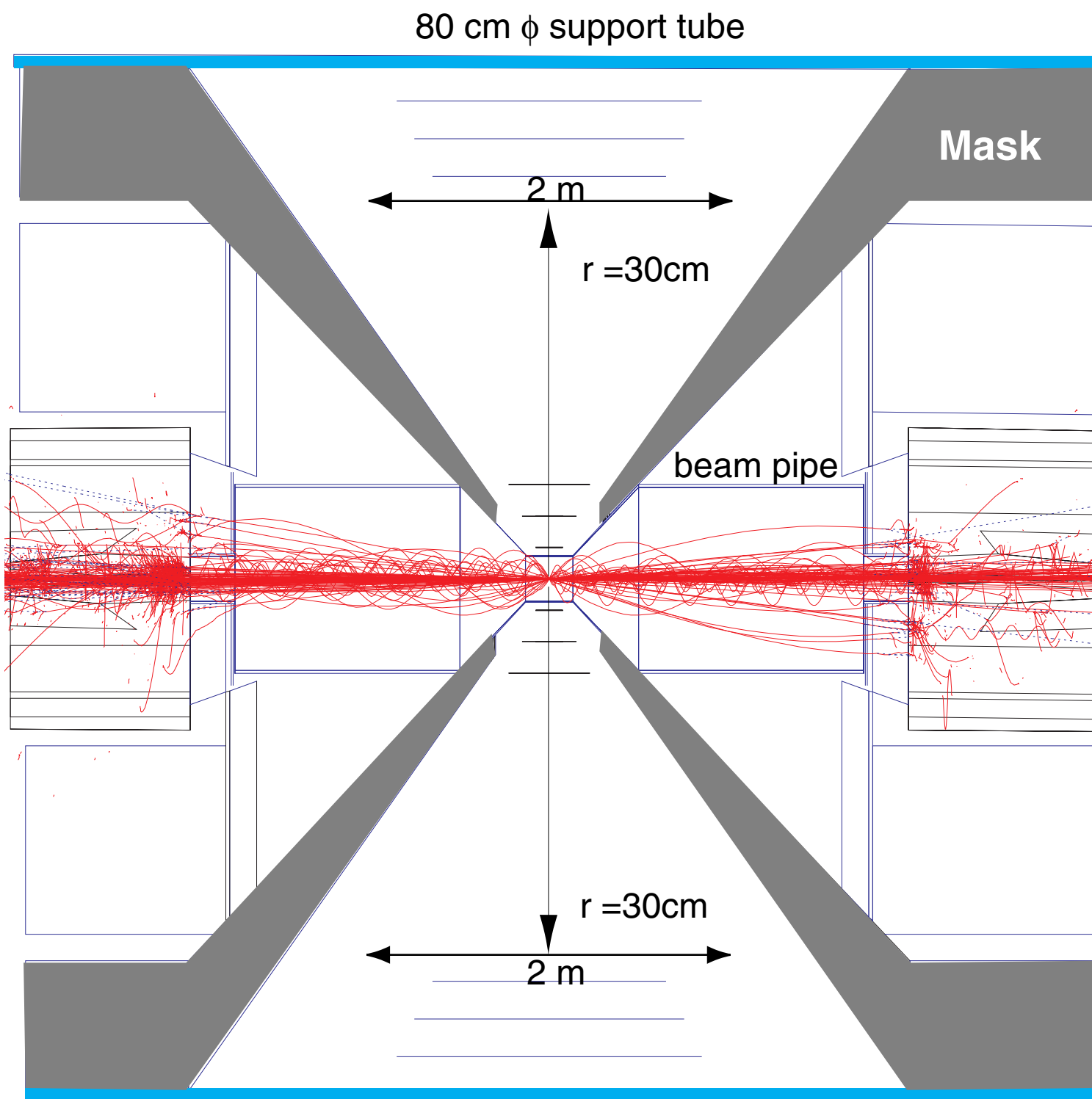

1/100 bunch and $E_{\gamma} > 100\text{MeV}$, $E_e > 10\text{MeV}$ for display purpose

JIM simulation for $E_{\gamma} > 10\text{keV}$, $E_e > 200\text{keV}$



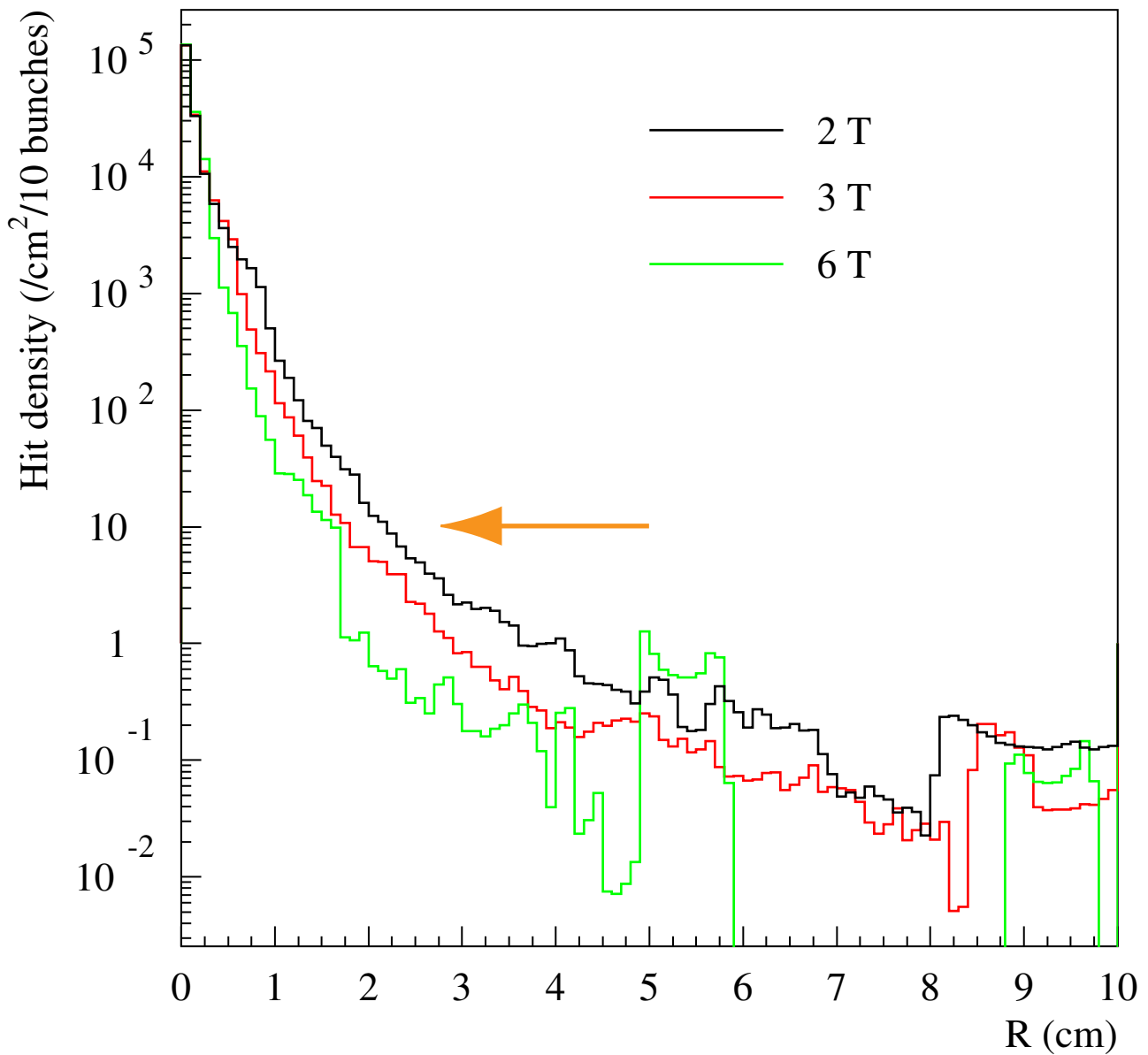

Vertex detector hit density in stronger B fields

$\cos \theta < 0.9$









Background tolerance

(1) CDC 10 % occupancy / train

r_{\min} \ B	2 tesla	3 tesla
2.5 cm hit#/train	 1.2 k (2.4 k)	 0.12 k (0.37 k)
1.8 cm		 0.72 k
1.5 cm hit#/train	 4.2 k	 2.6 k

(2) VTX 1 hit / mm² / train

r_{\min} \ B	2 tesla	3 tesla
2.5 cm hit#/mm ² /train	  0.9 (2.8)	 0.4 (1.0)
1.8 cm		 1.6
1.5 cm hit#/mm ² /train	 4.3	 3.6

Values in () are those of JLC-Y (high luminosity).

4,3 and 2cm ϕ beam pipes for r_{\min} =2.5, 1.8 and 1.5 cm, respectively.

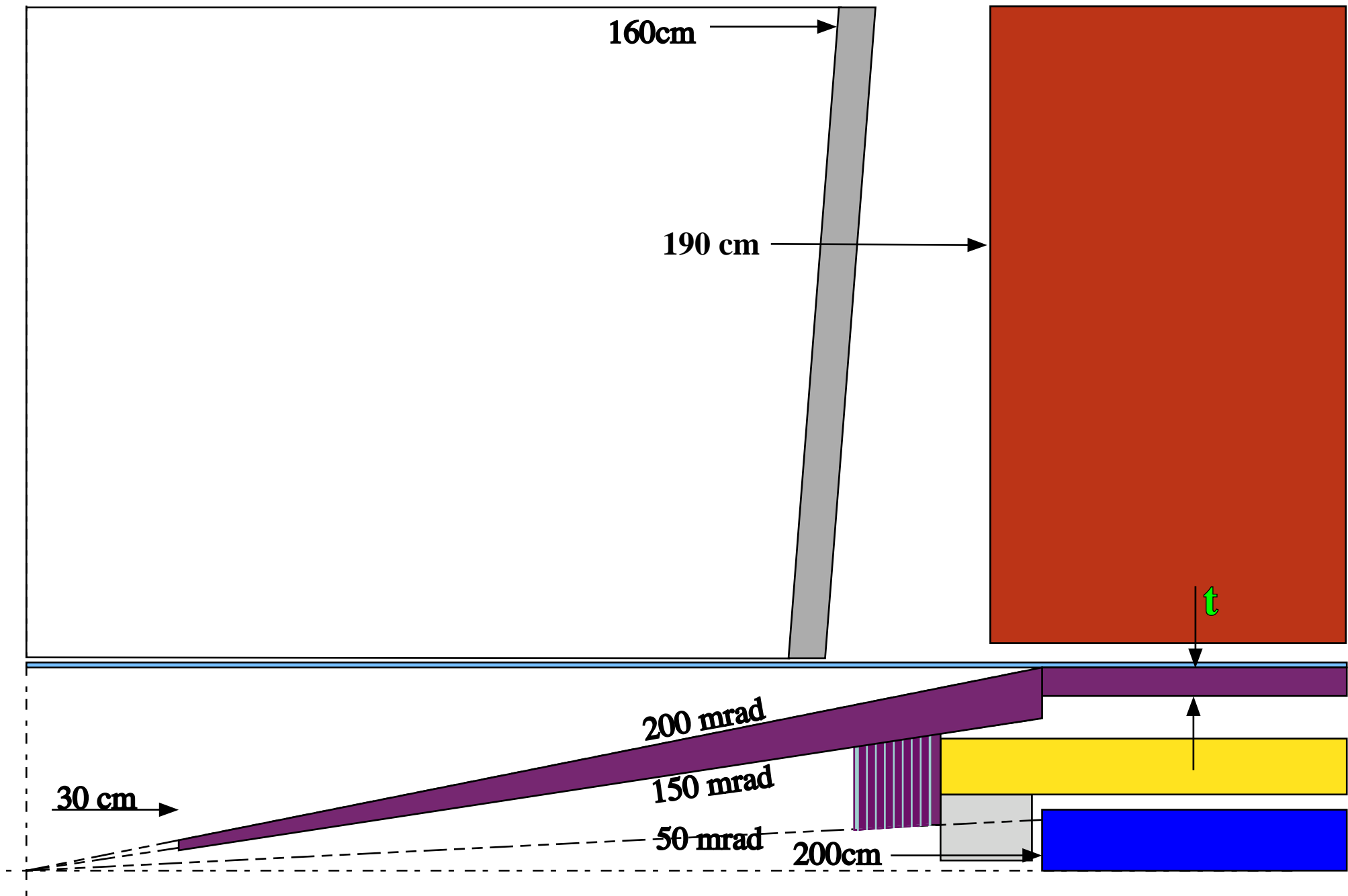

Energy Deposit in Calorimeter with W mask of different thickness

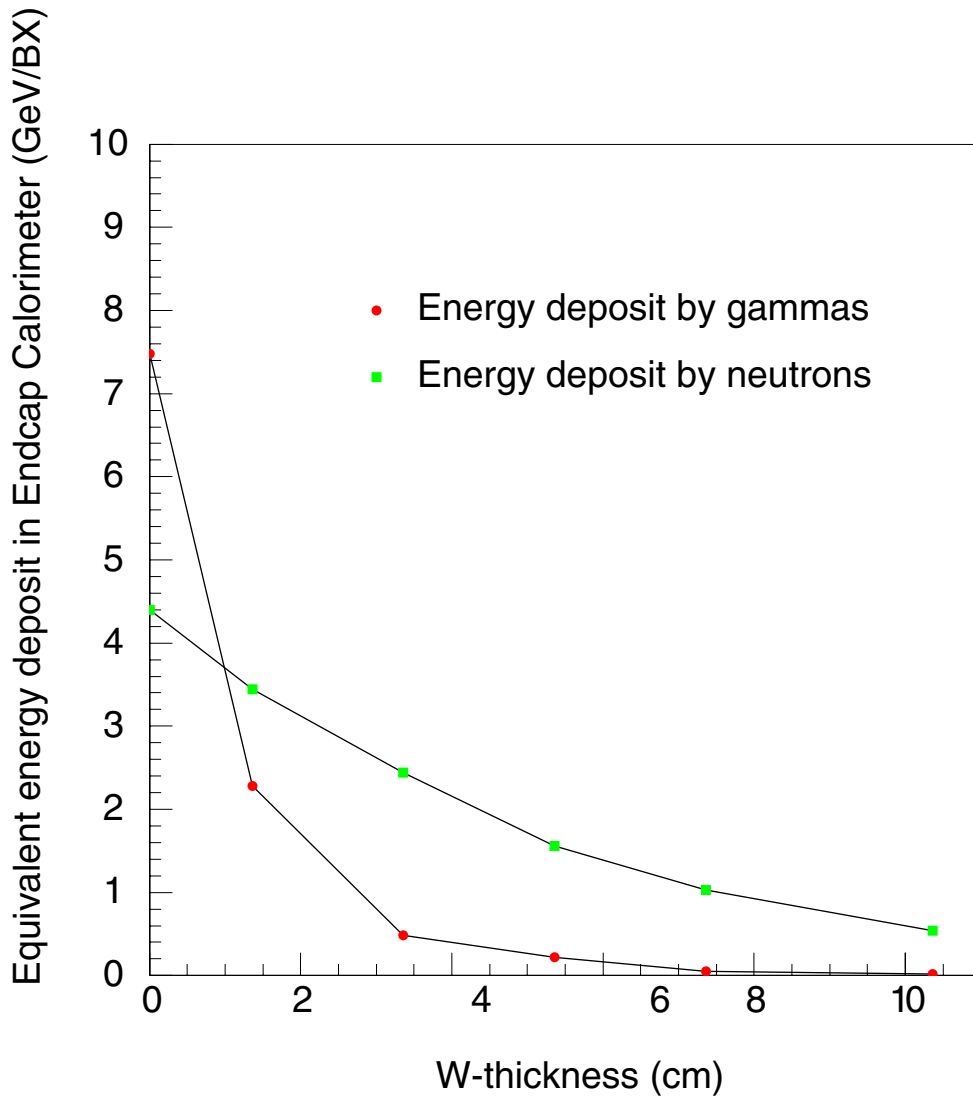

CDC Hits

	Gamma Hits/BX	Neutron Hits/BX
2T 10cm W-tube	0.3	20
2T 3cm W-tube	12	
2T w/o W-tube	340	
3T 10cm W-tube	~1	~1
3T 3cm W-tube	~1	~1
3T w/o W-tube	~1	~1
3T 10cm W-tube, small W-cone	~1	

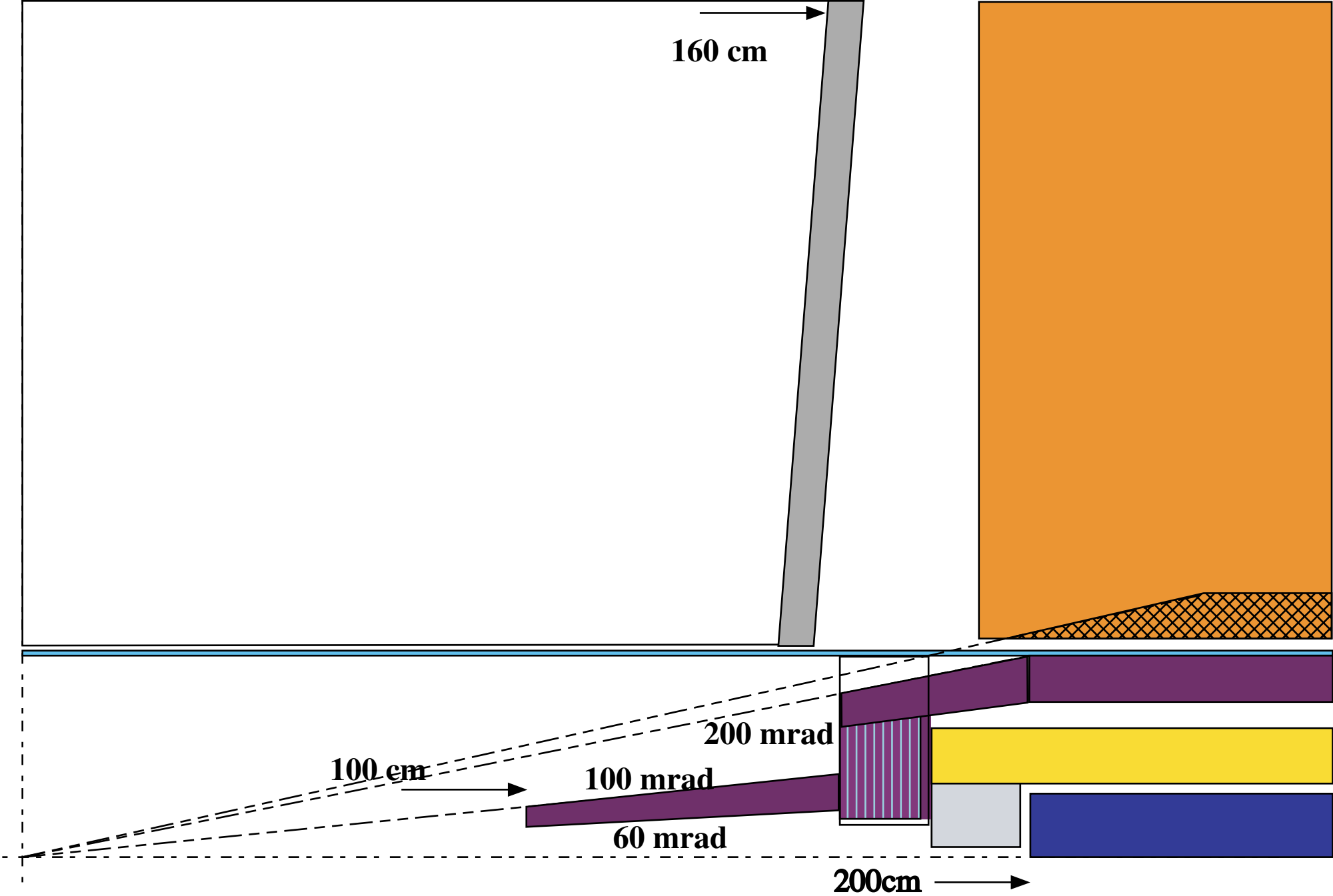

Summary of Neutron Background in VTX

Neutron yield at IP(/cm² /year)

e ⁺ e ⁻ :	Old (GEANT)	3x10 ⁷
	New(Fluka98) w 2T solenoid	5 x10 ⁷
	New(Fluka98) w. CC and QC	7 x10 ⁷
beamstrahlung: from beam dump(340kW) (300m from IP)	Old(GEANT)	1x10 ⁷
	New(Fluka98)	2.5x10 ⁷

Statistical error of new estimate is roughly a few x 10⁷ (guess)

New estimate based on Fluka98 is well below the requirement,

$$< 1.5 \times 10^{10} \text{ n/cm}^2$$

for the CCD vertex detector

Neutron background from other sources in dump line are under study.

Requirments for the Pair Monitor

- Detect a few 100 MeV electrons
- 30 hits/mm²/train
- ~50 kRad/year
- ~70 keV threshold to reject X rays.
- Identification of bunch in a train.
- Cover a circular area.

- Rate too high for a Si strip detector.
- CCD does not have TDC for each pixel.
- —→ active pixel sensor.

Use 100 x 100 m² pixel.

TDC on each pixel.

Gating to reduce occupancy.

Pixel Beam Profile Monitor

H. Yamamoto et al., University of Hawaii

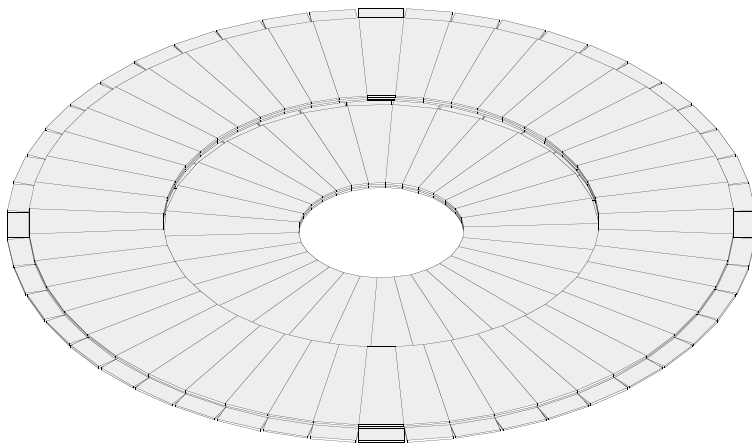

The sensor arrangement; the top side faces the IP.

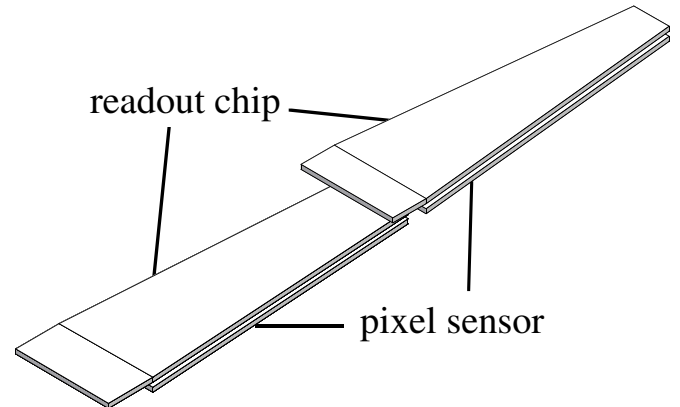

One 'segment' ; the bottom side faces the IP.

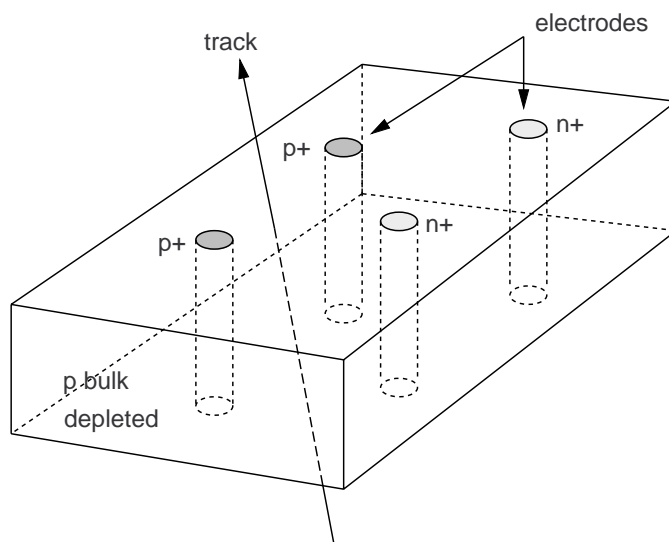

Schematic diagram of the 3D pixel concept

3D Pixel

1. Fast charge collection
< 1 nsec :bunch separation
2. Radiation hard
>>50kRad/year, 10^7 n/cm²/year
3. Flexible geometry
4. Active edge

3D Pixel Sensor IR Laser Test

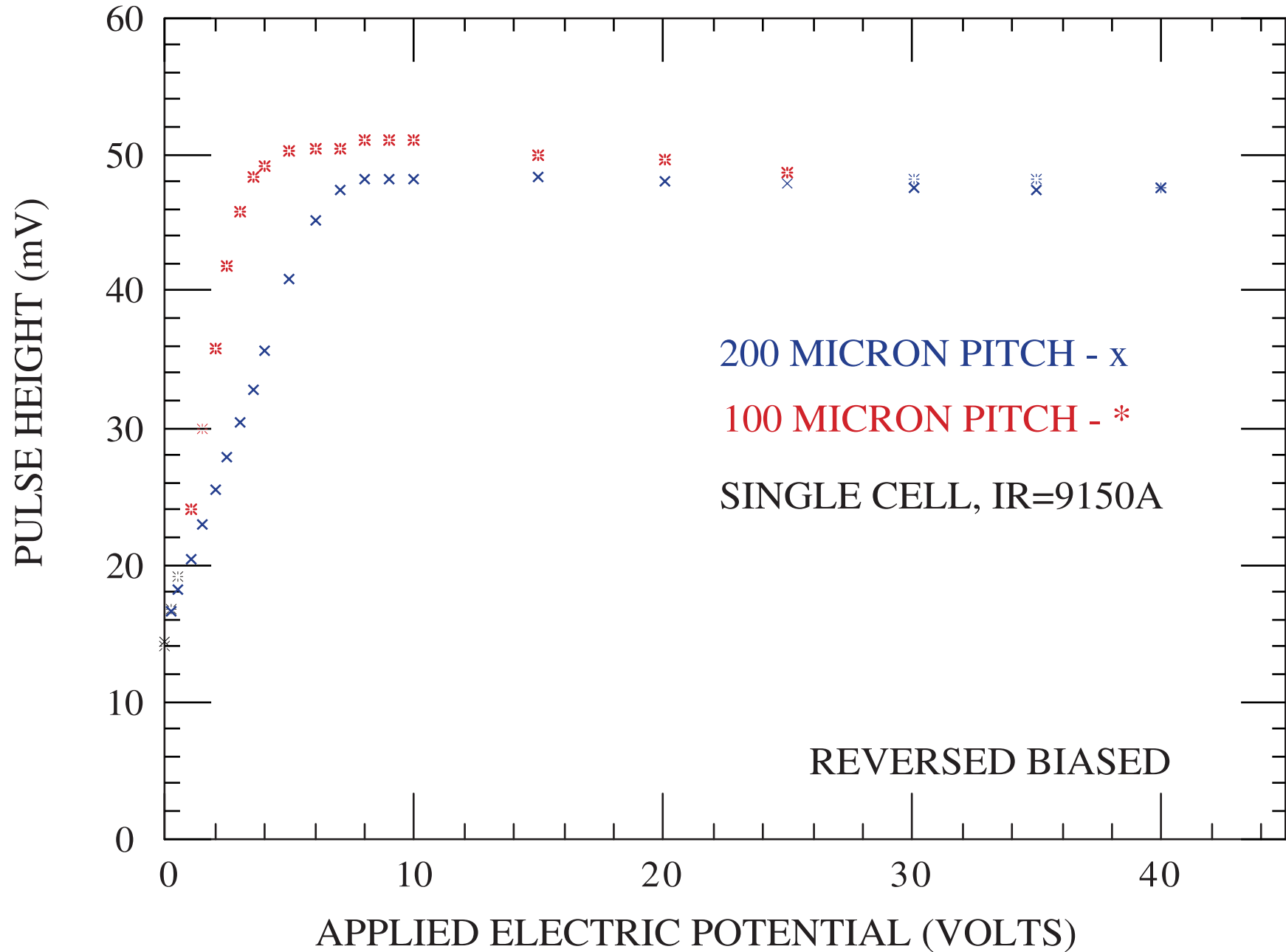

Possible Timing Circuit

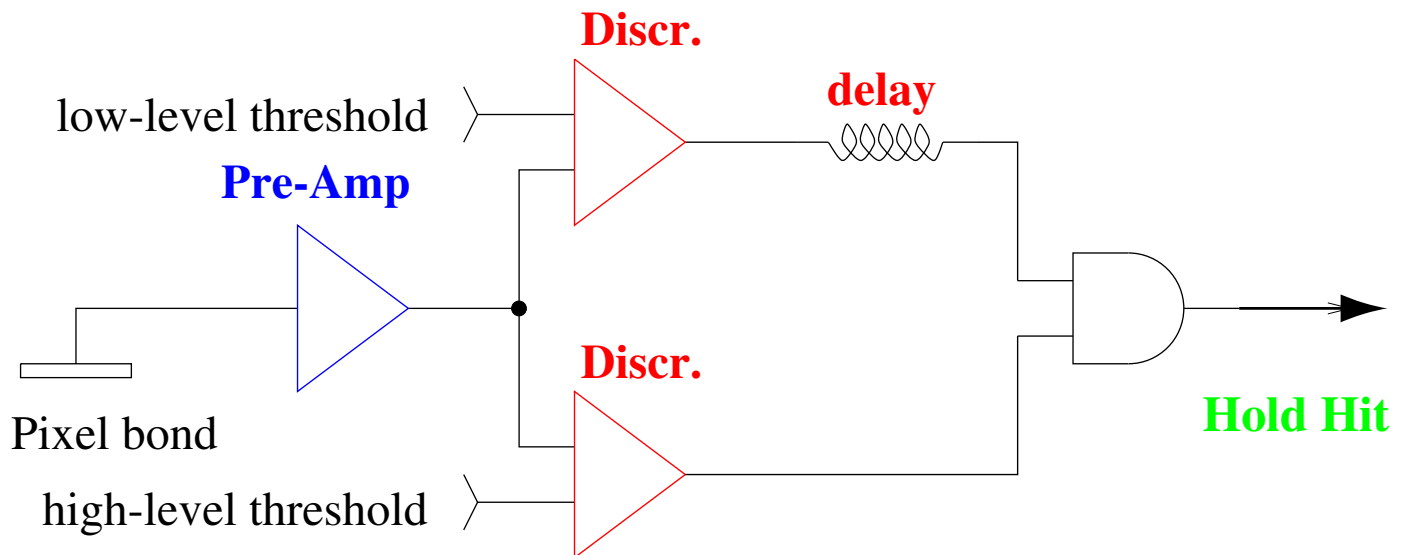

- Timing is defined by a low-threshold discriminator. Hit is defined by the high-threshold.
- Latch a counting gray code bus.
- TDC value stored on each pixel (~ 8 bits)
- Read-out time ~ 3.5 ms.

Alternative: V_{ramp} stored on a capacity in each pixel.

Optics of Dump Line (30 June 2000)

K.Kubo

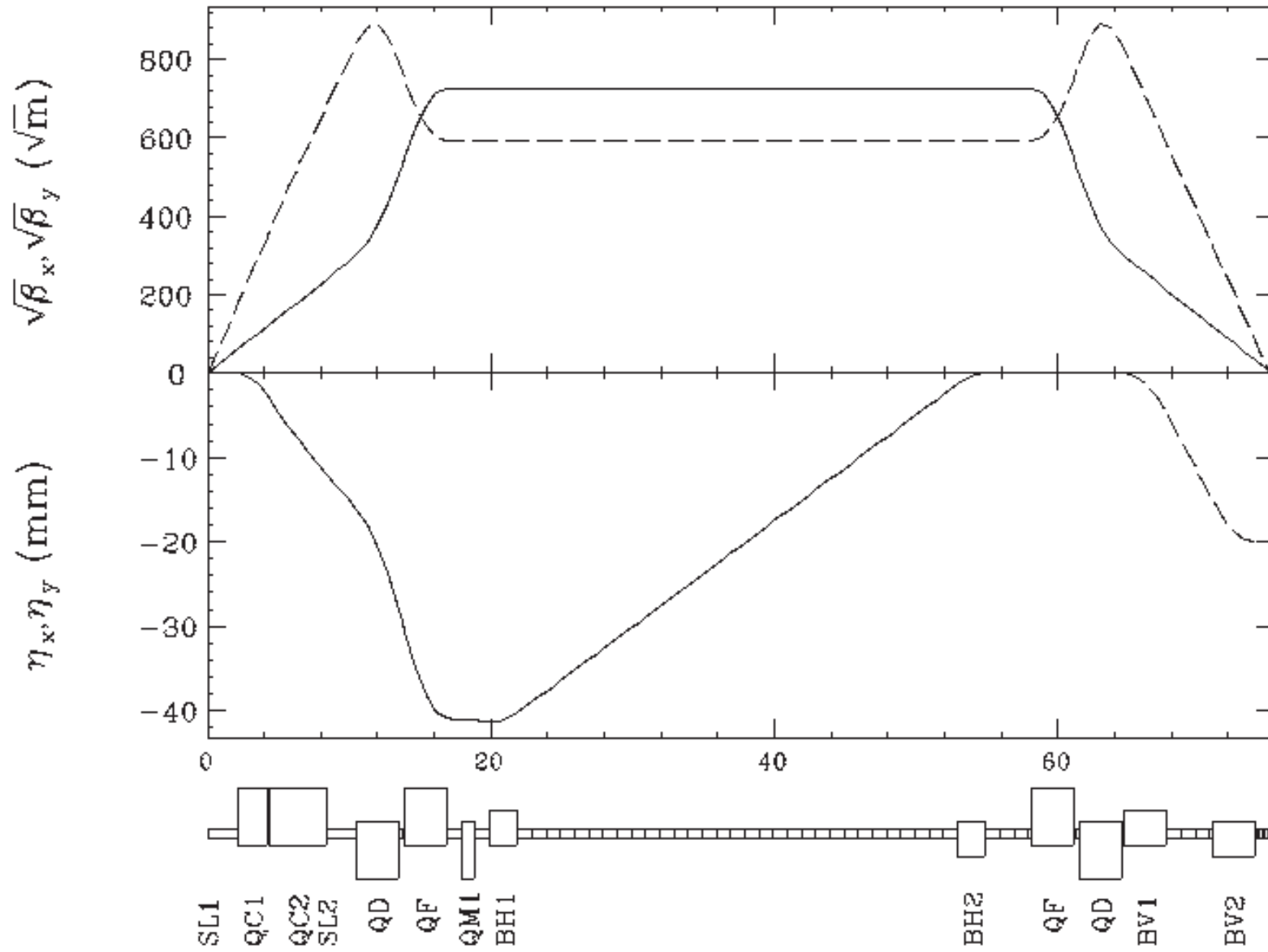

2nd focus
point

Measurements of
energy distribution
polarization

Ebeam=250 GeV

Aperture : (x1, x2, y1, y2) $x1 < x < x2$ and $y1 < y < y2$

QC1 entrance : (-0.01, 0.1, -0.01, 0.01)

QC1 exit : (-0.02, 0.1, -0.01, 0.01)

QC2 entrance : (-0.02, 0.1, -0.01, 0.01)

QC2 exit : (-0.08, 0.1, -0.05, 0.05)

QC2~ : (s*0.006, 0.1, -0.05, 0.05)

BV1, BV2 : (0.02, 0.02, -0.05, 0.05)

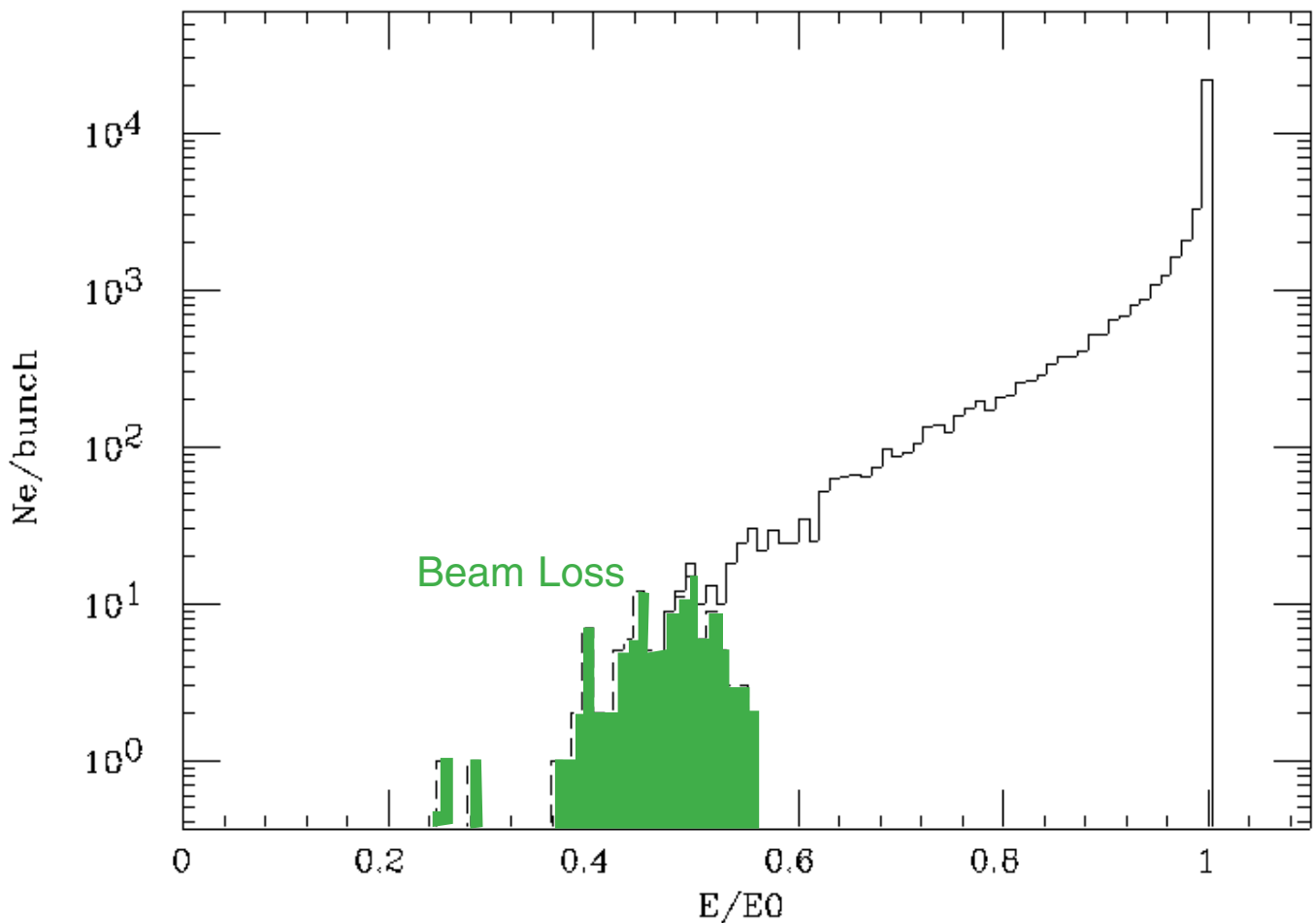

Aperture line and electron loss

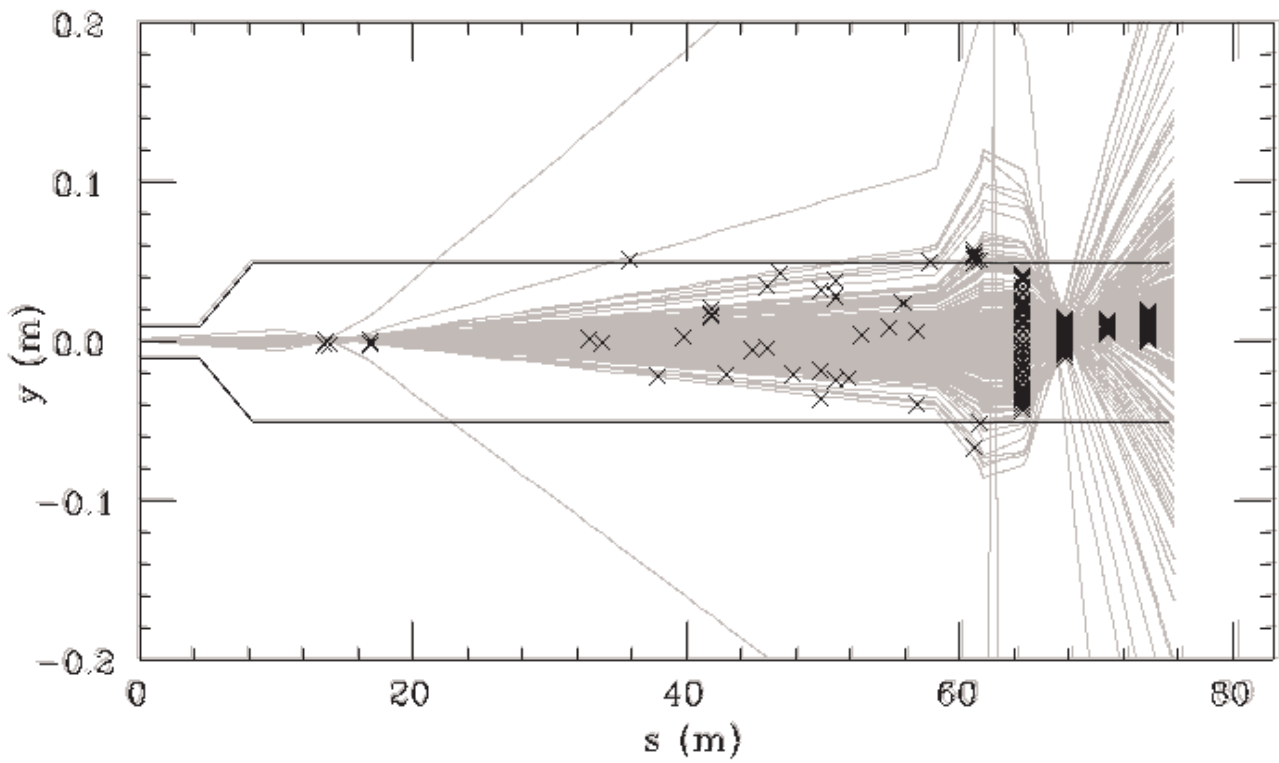
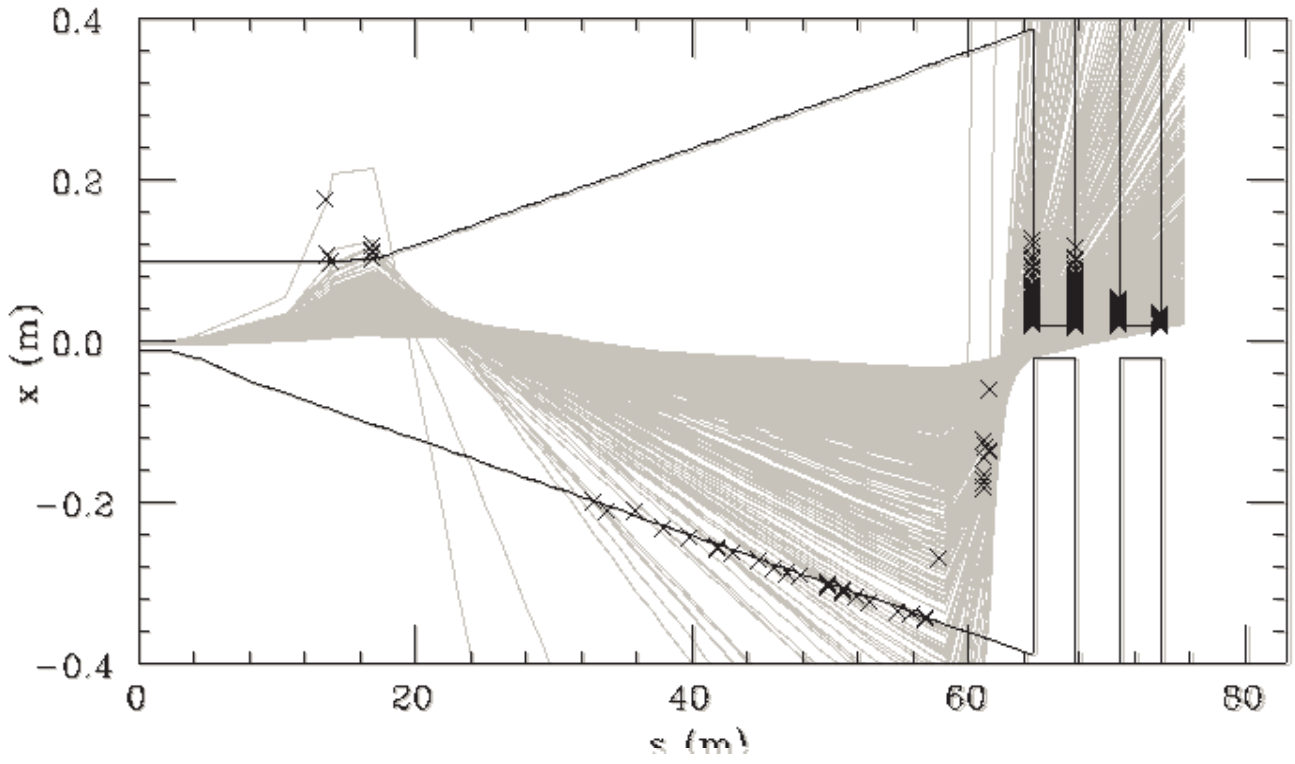

Eloss (W / m)

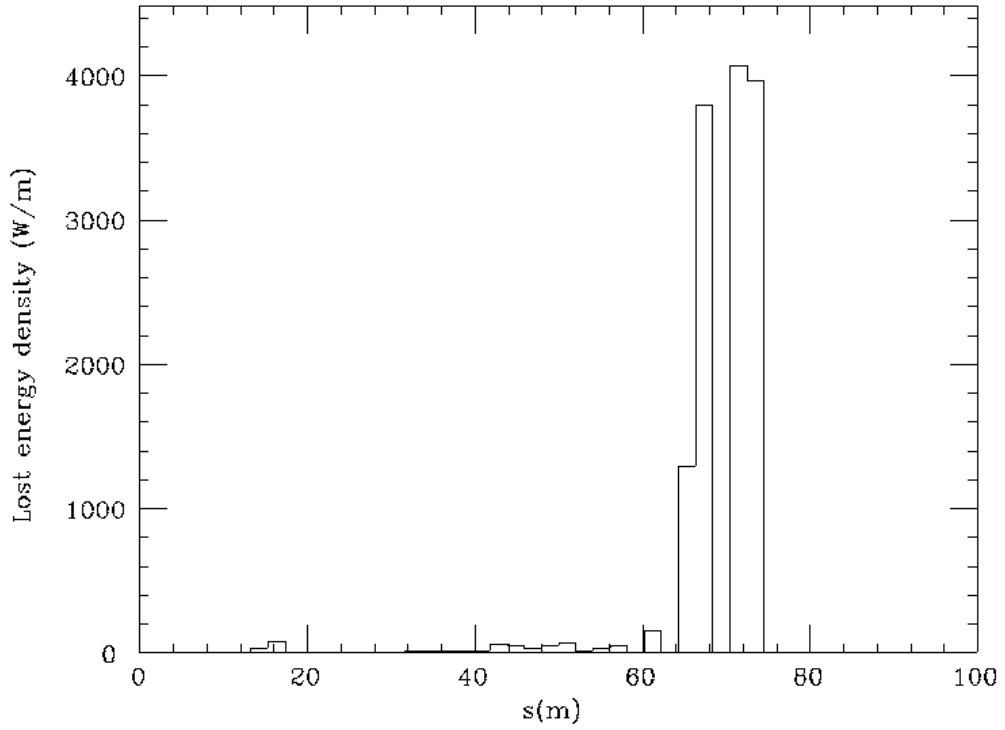

Neutrons ($\times 10^{10} / \text{cm}^2 / 10^7 \text{ sec}$), assuming 10^4 bunches/sec

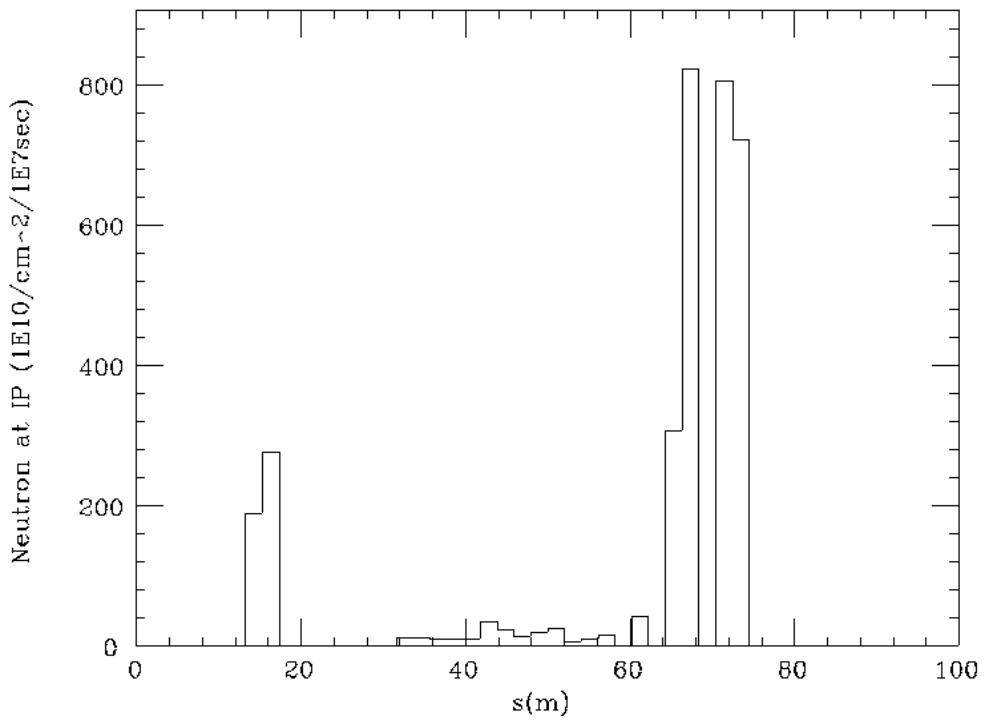

IR issues	JLC	NLC	tools	R&D other choices
Collimation	non-linear 1.2km/1.5TeV $6\sigma_x \times 40\sigma_y$	linear 2.4km/1TeV(1.5TeV?) $7\sigma_x \times 35\sigma_y$	SAD, EGS MUCARLO	wake field measurement detail tunnel geometry shorter collimation
muon background	6 cylinders (iron or lead) 0.6 ϕ x 120m	4 spoilers tunnel filler 3 x 3 x 9m ³		radio-activation in tunnel optimization with two schemes exotic : laser, liquid metal collimation....
Final Focus System	1.6 (0.6) km/1.5 (0.5) TeV	2.5 km -> 1 km by Pantaleo's FF optics	SAD, MAD	Tunability, 2 IP, μ bkg.
Crossing angle	8mrad toward smaller angle limited by SR backgrounds	20mrad toward larger angle, limited by "3 Tesla".	ABEL, CAIN, Guinea-Pig	tolerance for crab cavity requires 0.2° phase stability
Crab cavity	option (lum. 40% up) why? higher luminosity without crab cavity.	must why? easier extraction of disrupted beam.		needs prototype-cavity (measurement at SLAC, M.Ross) KEK B-factory crab cavity can be prototype?
Final focus Q-magnet	warm magnet, 2.2m long inner radius=6.85mm another option: superconducting QC1 w/o compensation magnet.	2 permanent magnets, 1m long each, + Q1SC(0.5m) inner radii=7 and 8 mm outer radii=2 and 2.5cm PEP-II experience 2m from IP, why?		warm magnet: water cooling w/o vibration permanent magnet: no beam-based alignment smaller angle: superconducting magnet how to extract beam?
	longer distance makes smaller dead cone and less background (back-scattered photons) and it must be benefit if it is set outside the compact detector. if $l^*=1m$, 25% shorter final focuss system if $l^*=3m$, 20% longer final focuss system			optics with large l^*

IR issues	JLC	NLC	tools	R&D other choices
Superconducting compensation magnet	must	no for small detector, must for large detector. (permanet magnet has no advantage with this?)		thinner cryostat for smaller dead cone
Detector solenoid	2 -> 3 Tesla	6 -3Tesla for small/large D. 20mrad crossing angle OK?	GEANT	Optimization of mag. field, calorimeter performance
Support of FF-Q vibration	support tube no additional "anchor" is necessary at TRISTAN tunnel. prototype in 2000.	optical anchor compact detector with support tube (grounded)	ANSYS	their prototypes calculations with measured ground motion.
Feedback	<p>Slow feedback(SLC type)</p> <p>collisions: can be corrected at <10Hz with BPM by using beam-beam deflection. O(nm) ground motion at >10Hz..... 5% lum. loss nm beam spot size: needs orbit correction by 10nm-res. BPMs</p>	<p>Slow feedback(<10Hz) fast feedback(2.8ns, <200Hz) by BPM with pilot beam and also by beam beam deflection.</p>	SAD,TURTLE, MERLIN,CAIN	SLC and B-factory's experiences feedback simulations 10-100nm resolution BPM.
Background: synchrotron radiation (SR)	no problem because of collimation and mask (for that from last bend).	similar to JLC but... needs recalculation	MQRAD QSRAD GEANT	SLD experineces, that is large fluctuation of the background in CDC. What is a stability of beam?

IR issues	JLC	NLC	tools	R&D other choices
Pair background	VTX: 0.9-0.4hits/mm ² /train by "electrons" at r=2.5cm for B=2-3 Tesla	VTX: 2-7 hits/mm ² /train at r=1.2cm for B=6-3 Tesla	ABEL,CAIN, Guinea-Pig GEANT,EGS	Detailed geometry at IP Tolerable background hits: VTX: < 1hit/mm ² /train CDC: occupancy < 1% radiation damage?
	CDC: 121-12 hits /train by "photons"	CDC: 3x10 ⁴ photons/train no gas chamber allowed		need cross check with common background-rays and geometries.
	at Ecm=500GeV	at Ecm=1TeV		Comparison between ABEL, CAIN and Guinea-Pig.
		This result may be consistent with JLC because of "photon conversion" in the chamber and its higher beam energy.		
neutron backgrounds from pairs, (disrupted beam and beam dump)	10 ⁶ n/train (n/E _e =0.13/GeV) VTX: 7 x10 ⁷ hits/cm ² /year	VTX: 2.2-4.7 x10 ⁹ hits/cm ² /year	GEANT FLUKA98	Tolerable background hits: CCD/VTX < 1.5x 10 ¹⁰ hits/cm ² so, no problem.

Instruments

	IR issues	JLC	NLC	tools	R&D other choices
	Pair monitor	3D pixel detector Hawaii university	??? Very big SR background! How does SR background fluctuate event by event inside masks at SLD ?	ABEL,CAIN, Guinea-Pig GEANT	pixel device(50x50 μm^2) with dE/dX measurement. What's kind of feedback?
	Shintake monitor				Laser optics close to IP? σ_x measurement at least
	IP-BPM				O(10nm) resolution
	Luminosity meas.	acollinearity angle of Bhabha scattering		Toomi's program	How to measure luminosity distribution within a beam energy spread(1%) ? (toponium physics)
	Beamstrahlung monitor				
Extraction Beam Line	Radiative Bhabha meas		There is a chicane in extraction beam line to separate electron beam and photons with a common dump.	ABEL,CAIN, Guinea-Pig SAD GEANT	Design extraction lines and beam diagnostic equipments for small(JLC) and large (NLC) crossing angles.
	Energy measurement	using vertical dispersion			
	Polarization measurement	Hirose's talk at LCWS95 (Appi, Morioka)			
	Beam dump				

Future Plan

1. IP layout will be optimized for the high luminosity upgrade.

JLC-Y : 1.4nsec bunch spacing,
190 bunches/train
stronger beamstrahlung effects

2. “Pre-linac” collimation scheme must be established.

It means collimation before the main linac.

It may simplify the collimation system and the muon protection.

3. Superconducting QC1 is seriously considered.

The design shall be based on experiences of LHC-QC magnets, adding new features of correction magnets near the beam line for nano-meter beams.

Prototype of QC1 must be necessary.

4. More detailed study on the support system will be pursued with respect to ground motions.

Prototype system must be constructed to verify our estimations.

5. Background studies will continue based on detailed simulations with up-to-date geometries, especially for the neutron background.

6. The realistic design of the pair monitor shall be promoted by a collaboration between University of Hawaii and KEK. It will be finalized in this autumn.

7. R&D of active mask and luminosity monitor will be initiated by National Taiwan University group.

8. The “actual” dump line must be designed in order to control beam losses for the neutron backgrounds.

Experimental methods must be established for measurements of beam energy spread and polarization.

9. All efforts should be concentrated for the first draft of the CDR in this autumn.